

DESIGN GUIDE

D-BACS*

Interface for use in LON WORKS®

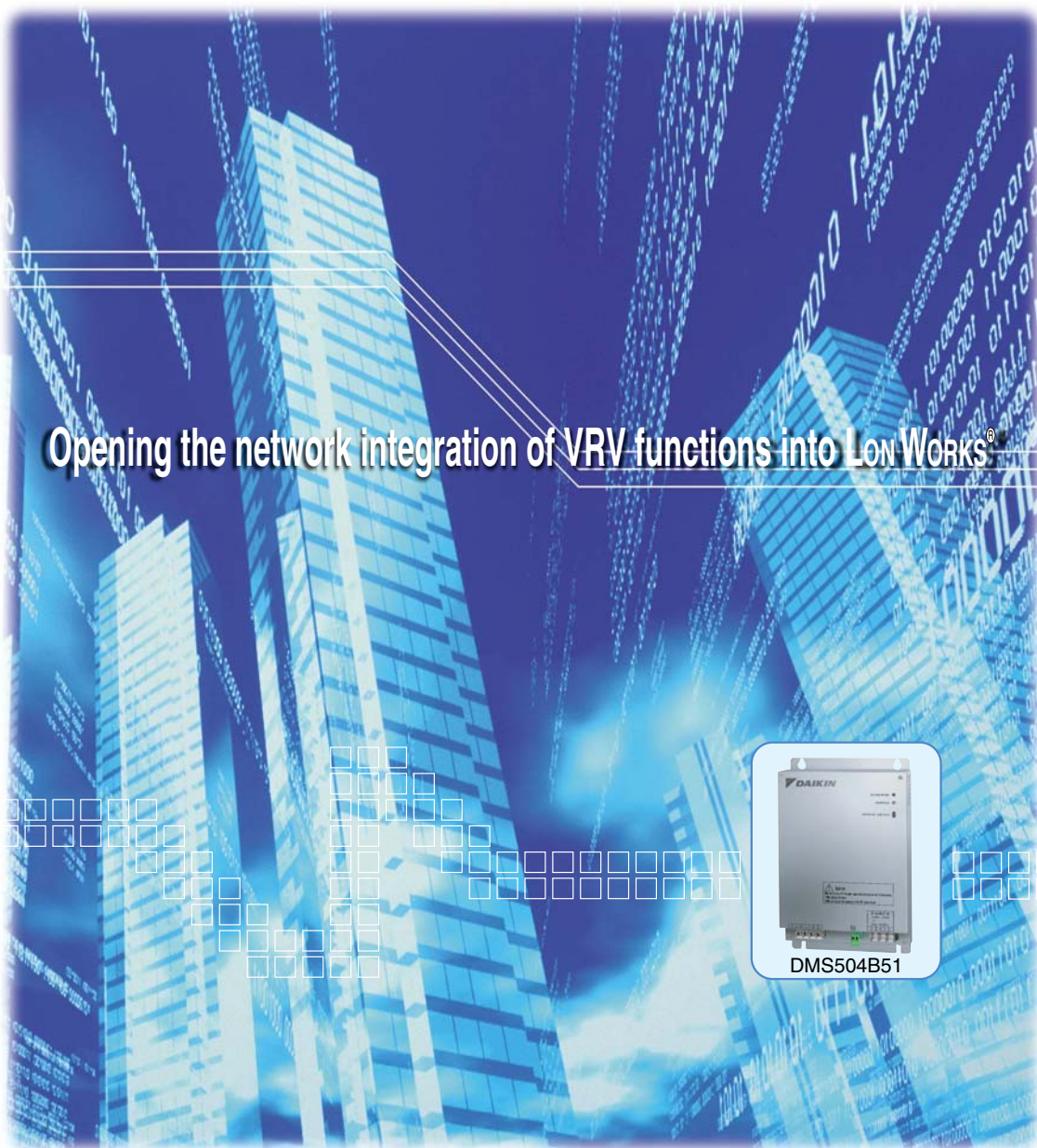

Opening the network integration of VRF functions into LON WORKS®



DMS504B51

LONWORKS, LON and LonTalk are registered trademarks of Echelon corporation.
LONMAKER is a trademark of Echelon corporation.

*DAIKIN-Building Air-conditioning control system.

Part 1 Product Specifications.....	1
1. Introduction	2
2. System Configuration	2
3. Overview of Functions.....	3
4. Applicable Models	4
5. Specifications of Devices	5
6. Hardware.....	6
6.1 Physical Appearance and Branch Connection	6
6.2 Definition of LED and Switch.....	6
7. Object Details.....	7
7.1 Node Objects.....	7
7.2 DIII-NET Common Objects.....	7
7.3 Air Conditioner Objects	8
8. Details of Network Variables	9
8.1 Node Objects.....	9
8.2 DIII-NET Common Objects.....	10
8.3 A/C Objects (AC_01 to AC_64).....	12
8.4 Configuration Properties.....	22
9. Precautions regarding XIF Files.....	25
9.1 File Name	25
9.2 Limitations with Version 3.....	25
9.3 Unused Network Variables.....	25
10. Notes for when Commissioning	25
10.1 Suspension of Message Transmission when Receiving Set Node Mode Online	25
11. Reference Materials (Error Code Conversion Table).....	26
 Part 2 Control-related Design Keypoints.....	 27
1. Introduction	28
2. System Configuration	29
2.1 A/C Units to be Monitored and Controlled.....	29
2.2 Number of A/C Units to be Monitored and Controlled	29
2.3 Location Address Setting and Combined Use of Other Centralized Devices	29
3. Hardware.....	31
3.1 Schematic Diagram of the Hardware	31
4. Outline of Functions	32
4.1 Outline of Function Via LON.....	32
4.2 Function of Contact Input	32
4.3 Control and Monitoring Items	33
4.4 Setting/Monitoring Restrictions from LON according to A/C Unit Model/Installation Method	36
5. LON Communication Specifications.....	37
5.1 LonMark Template Profiles	37
5.2 LonMark Certification	37

5.3	Object	37
5.4	Configuration Properties	37
6.	Monitoring and Control Restrictions	39
6.1	Restrictions Regarding the 'System Forced OFF' Function	39
6.2	Operation Mode Changeover Restrictions	40
6.3	LON Address Table Restrictions	41
6.4	Suspension of Message Transmission when Receiving Set Node Mode Online	41
6.5	Group Binding Restrictions	41
6.6	Prohibition Time of Commands from LON (central monitoring panel) when Power is Restored after Power to A/C Units is Cut	41
6.7	Room Temperature Report	41
6.8	Change of Settings	41
Part 3	Check Sheet for Control and Monitoring Items	43
1.	Workflow	44
2.	Check Sheet for Control and Monitoring Items	45
Part 4	Open Network Glossary	49
1.	Open Network Glossary	50
Part 5	LON (Interface for use in LONWORKS®) Q&A	55
1.	LON (Interface for use in LONWORKS®) Q&A	56
Part 6	Daikin's LON Binding Agreement	63
1.	Daikin's LON Binding Agreement	64
Part 7	Interface for use in LONWORKS® Commissioning Manual MODEL:DMS504B51	65
1.	Foreword	66
2.	Procedure for Commissioning	67
3.	Setting the Service PC	68
3.1	Communication Specification	68
3.2	RS232C Cable Connecting Diagram	68
3.3	Hyperterminal (VT Terminal Emulation) Setting	69
4.	Connection to Service PC and Start	71
4.1	Wiring	71
4.2	Starting Hyperterminal	71
5.	Operation Check	72
5.1	Check the Status of DIII Network	73
5.2	Indoor Unit Operation	73
6.	Binding Work	74
7.	LED Indication	75
8.	Terminal Resistance	76

8.1 How to Set Terminal Resistance	76
9. Appendix 1 Service PC Command Function	77
10. Check List	79
11. Troubleshooting	80
12. Others	81
12.1 Backup Battery Switch for The Interface for LONWORKS®	81
12.2 Power Supply Voltage of The Interface for LONWORKS®	81
Part 8 Installation Manual(DMS504B51)	83
1. Installation Manual	84
1.1 DMS504B51	84
Part 9 Troubleshooting	91
1. Troubleshooting	92
1.1 Alive/Wink Green LED Does Not Blink. Alive/Wink Green LED Blinks, However, H8 Alive LED Does Not.	92
1.2 Communication with the Central Monitoring Panel Can Not be Established. The Service LED Blinks or Lights Up.....	93
1.3 Alarm Indication (Error MA, MC, M1) is Displayed During Checking DIII - Net Condition.....	94
1.4 Test Run.....	95
Appendix	96

Part 1

Product Specifications

1. Introduction	2
2. System Configuration	2
3. Overview of Functions.....	3
4. Applicable Models	4
5. Specifications of Devices	5
6. Hardware.....	6
6.1 Physical Appearance and Branch Connection	6
6.2 Definition of LED and Switch	6
7. Object Details	7
7.1 Node Objects.....	7
7.2 DIII-NET Common Objects.....	7
7.3 Air Conditioner Objects	8
8. Details of Network Variables	9
8.1 Node Objects.....	9
8.2 DIII-NET Common Objects.....	10
8.3 A/C Objects (AC_01 to AC_64).....	12
8.4 Configuration Properties.....	22
9. Precautions regarding XIF Files.....	25
9.1 File Name	25
9.2 Limitations with Version 3.....	25
9.3 Unused Network Variables.....	25
10. Notes for when Commissioning	25
10.1 Suspension of Message Transmission when Receiving Set Node Mode Online	25
11. Reference Materials (Error Code Conversion Table).....	26

Note: Echelon, LON and Lonworks are trademarks of Echelon Corporation registered in the United States and other countries.

CA02A552

1. Introduction

This publication represents the specifications relating to the LonWorks Network functions and specifications used when Daikin's VRV or DIII-NET compatible A/C is hooked up to a LonWorks® Network.

2. System Configuration

This LON Gateway can be connected (hooked up) to a maximum of 64 indoor units in a group.

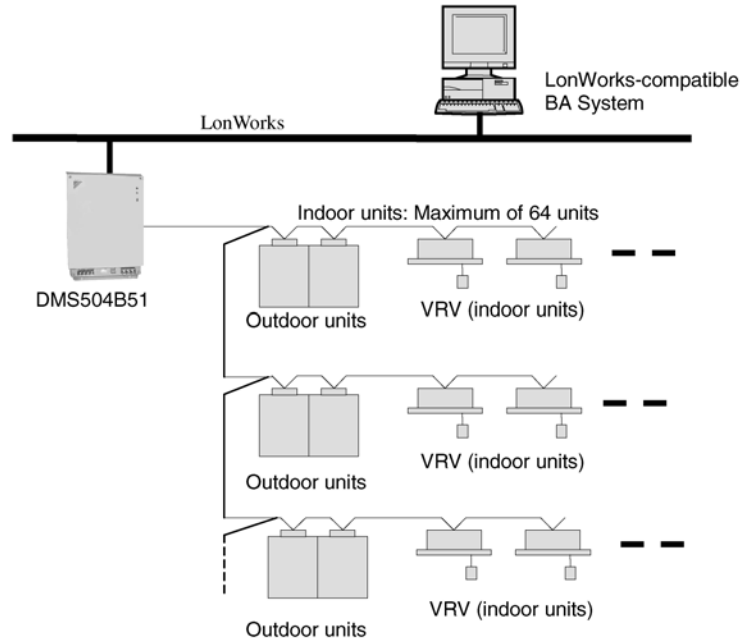

Note:

The LON Gateway functions as the interface for a building monitoring system and cannot be co-installed on the DIII-NET along with the following equipment/devices that have similar functions.

- Interface for BACnet Gateway for overseas markets
- DDS
- iPU (i-Manager)
- Adapter for remote control
- Parallel interface

3. Overview of Functions

	Function	Description
Controlling items	ON/OFF Command	Starts/stops air conditioner operation.
	Operation Mode Setting	Sets operation mode (heating/cooling/ventilation/auto).
	Temperature Setting	Sets room temperature.
	Airflow Rate Setting	Sets airflow rate.
	Filter Sign Reset	Resets filter sign.
	Forced Thermostat OFF Setting	Sets forced thermostat OFF.
	Remote ON/OFF Control Rejection	Sets whether permit/prohibit ON/OFF control rejection of the air conditioner with a hand-held remote controller.
	Remote Operation Mode Control Rejection	Sets whether permit/prohibit operation mode control rejection of the air conditioner with a hand-held remote controller.
	Remote Temperature Setting Control Rejection	Sets whether permit/prohibit room temperature setting control rejection of the air conditioner with a hand-held remote controller.
	System Forced OFF Setting	Forcibly stops the air conditioner connected to the DIII-NET /Resets the Forced OFF setting.
	Sub Group Address Control Rejection Setting	Permits/prohibits controlling of the centralized device connected to the DIII-NET.
Monitoring items	ON/OFF Status Report	Monitors ON/OFF status of the air conditioner.
	Operation Mode Status Report	Monitors operation mode status (heating/cooling/ventilation) of the air conditioner.
	Temperature Setting Report	Monitors the set room temperature.
	Room Temperature Report	Monitors the room temperature.
	Airflow Rate Setting Report	Monitors the set airflow rate.
	Filter Sign Report	Checks limits of filter use and monitors if it has reached the limit.
	Error Status Report	Monitors error status of the air conditioners.
	Error Code Report	Displays the manufacturer-specified error codes if any errors occur.
	Thermostat Status Report	Monitors whether the air conditioner's thermostat is working.
	Forced Thermostat OFF Setting Status Report	Monitors the forced thermostat OFF status.
	Remote ON/OFF Operation Rejection Report	Monitors the status if the air conditioner is permitting/prohibiting remote ON/OFF control with a hand-held controller.
	Remote Control Operation Mode Setting Rejection Report	Monitors the status if the air conditioner is permitting/prohibiting remote control operation mode with a hand-held controller.
	Remote Control Temperature Setting Operation Rejection Report	Monitors the status if the air conditioner is permitting/prohibiting remote control temperature setting with a hand-held controller.
	System Forced OFF Setting Report	Monitors the status of the forced OFF setting of the air conditioner connected to the DIII-NET.
	Sub Group Address Control Operation Rejection Setting Report	Monitors the status if the air conditioner is permitting/prohibiting control of a centralized device connected to the DIII-NET.
A/C Communication Status Report	Monitors the communication status (No Occupancy/ Communication normal/ Communication error) of the air conditioner.	

4. Applicable Models

Function Names	VRV	HiSky Multi	Sky Air	HRV	Outdoor Air Processing Unit FXYM-KF, MF	Wiring Adaptor for Other Air Conditioner	Central Control Adaptor Kit	Fan Coil Controller *15	Fan Unit *14 *15
ON/OFF Command	○	○	○	○	○	○	○	○	○
Operation Mode Setting	○	○	○	×	○	×	○	○	×
Temperature Setting	○	○	○	×	× (Not settable by remote controller)	×	○	○	×
Airflow Rate Setting	○	○	○	×	×	×	×	Δ (Only Quick/Soft)	×
Filter Sign Reset	○	○	○	○	○	×	×	○	×
Forced Thermostat OFF Setting	○	○	○	×	○	×	×	×	×
Remote ON/OFF Control Rejection	○	○	○	○	○	×	○	○	○
Remote Operation Mode Control Rejection	○	○	○	×	○	×	○	○	×
Remote Temperature Setting Control Rejection	○	○	○	×	○	×	○	○	×
System Forced OFF Setting	○	○	○	○	○	○	○	○	○
Sub Group Address Control Rejection Setting	*This is a controlling item for subsidiary central operation equipment.								
ON/OFF Status Report	○	○	○	○	○	○	○	○	○
Operation Mode Status Report	○	○	○	×	○	×	○	○	×
Temperature Setting Report	○	○	○	×	×	×	○	○	×
Room Temperature Report	○	○	○	×	○ (Temperature at the blow-off outlet)	×	○	Δ (Only thermostat for sucking into body)	×
Airflow Rate Setting Report	○	○	○	×	× (First speed fixed)	×	×	Δ (Only Low/High)	○
Filter Sign Report	○	○	○	○	○	×	×	○	×
Error Status Report	○	○	○	○	○	○	○	○	×
Error Code Report	○	○	○	○	○	×	○	○	○
Thermostat Status Report	○	○	○	×	○	×	×	×	×
Forced Thermostat OFF Setting Status Report	○	○	○	×	○	×	×	×	×
Remote ON/OFF Operation Rejection Report	○	○	○	○	○	×	○	○	○
Remote Control Operation Mode Setting Rejection Report	○	○	○	×	○	×	○	○	×
Remote Control Temperature Setting Operation Rejection Report	○	○	○	×	○	×	○	○	×
System Forced OFF Setting Report	○	○	○	○	○	○	○	○	○
Sub Group Address Control Operation Rejection Setting Report	*This is a sub group address controlled central operation equipment.								
A/C Communication Status Report	○	○	○	○	○	○	○	○	○

*1 Engineered & Industrial Systems Div. prohibits a connection between the fan unit and Ve-up controllers (and other central operation equipment).

*2 For Δ parts, consult with Engineered & Industrial Systems Div.

5. Specifications of Devices

Item	Specifications
Model	DMS504B51
Dimensions	168 (W) × 260 (H) × 50 (D) mm
Weight	1.5 kg
Power source	Single phase AC100~240V 50/60Hz
Power consumption	Max. 5W
Operable temperature range	-10 to 50 °C
Storage temperature range	-20 to 60 °C
Humidity	Up to 95% (No condensation)
Installation	Mounted to indoor distribution board
LonWorks	FT-X1 (Free topology 78Kbps)
Contact input	Forced OFF × 1 (A/Cs en bloc)

6. Hardware

6.1 Physical Appearance and Branch Connection

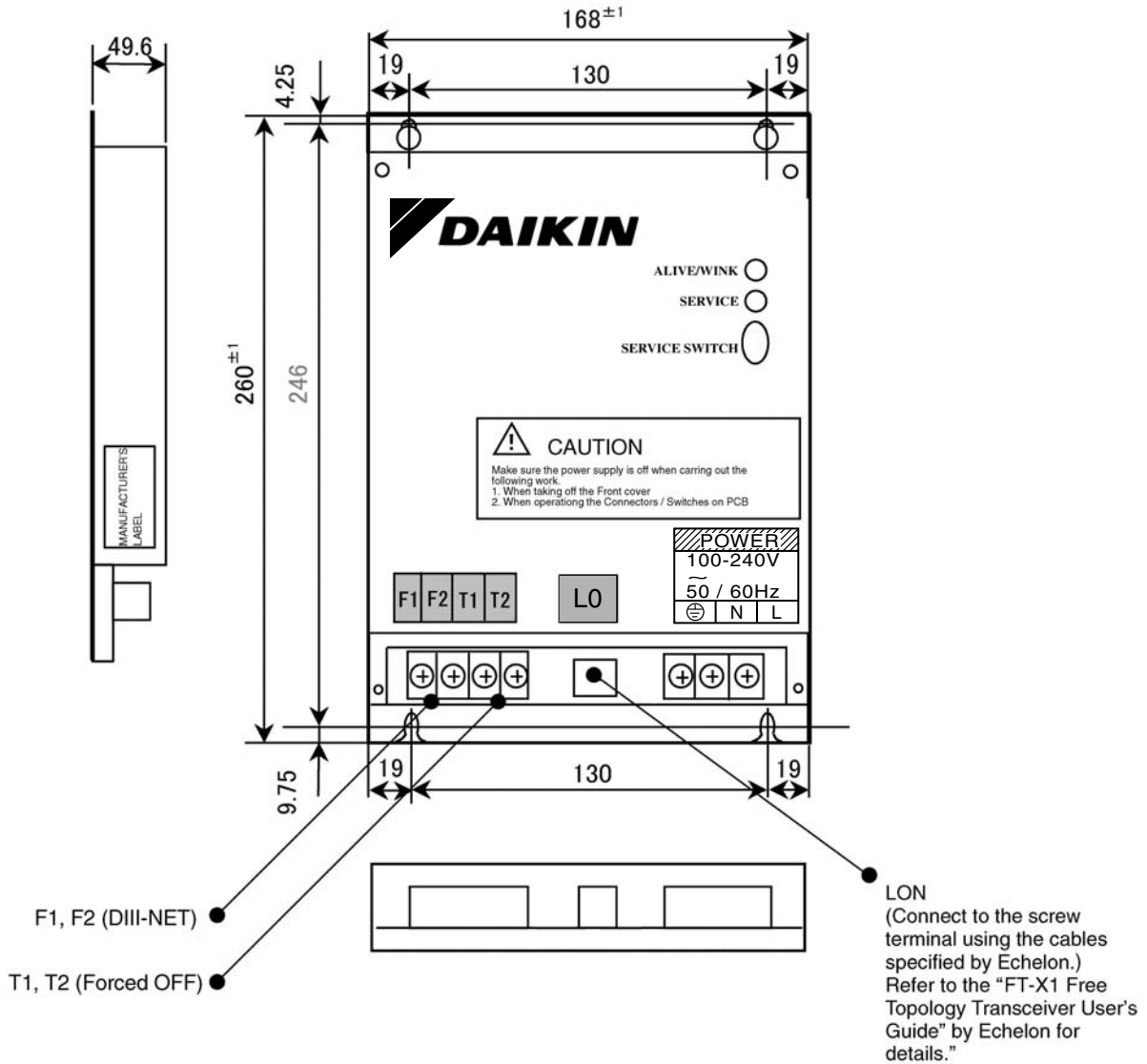

6.2 Definition of LED and Switch

1. LED

ALIVE/WINK	CPU normal monitor	Green	Normal	Blinking every 0.4 sec.
		Red	WINK command reception	Blinking every 0.2 sec.
SERVICE	LON status	Yellow	Normal	Light off
			Unconfigure state	Blinking every 0.51 sec.
			SERVICE SW on	Light on
			Error	Blinking/flushing every 0.84 sec.

2. Switch

SERVICE SW Neuron ID is sent upon pushing this switch.

7. Object Details

7.1 Node Objects

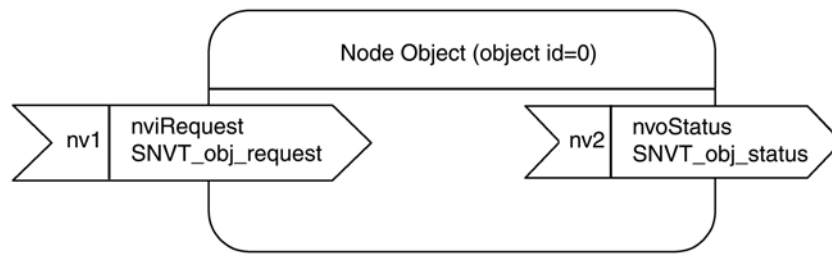

7.2 DIII-NET Common Objects

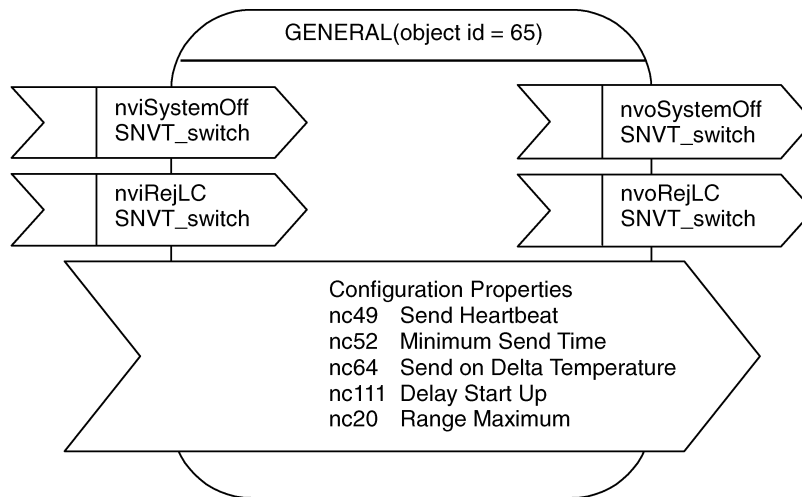

7.3 Air Conditioner Objects

It features objects for a group of 64 indoor units.

As shown below, the object name and the last "_nn" in the "nv Name" correspond with the DIII-NET location setting address.

Indoor Unit Location Setting Address	A/C Object	nv Name (Example)
1-00 - 1-15	AC_01 - AC_16	nviOnOff_01 - nviOnOff_16
2-00 - 2-15	AC_17 - AC_32	nviOnOff_17 - nviOnOff_32
3-00 - 3-15	AC_33 - AC_48	nviOnOff_33 - nviOnOff_48
4-00 - 4-15	AC_49 - AC_64	nviOnOff_49 - nviOnOff_64

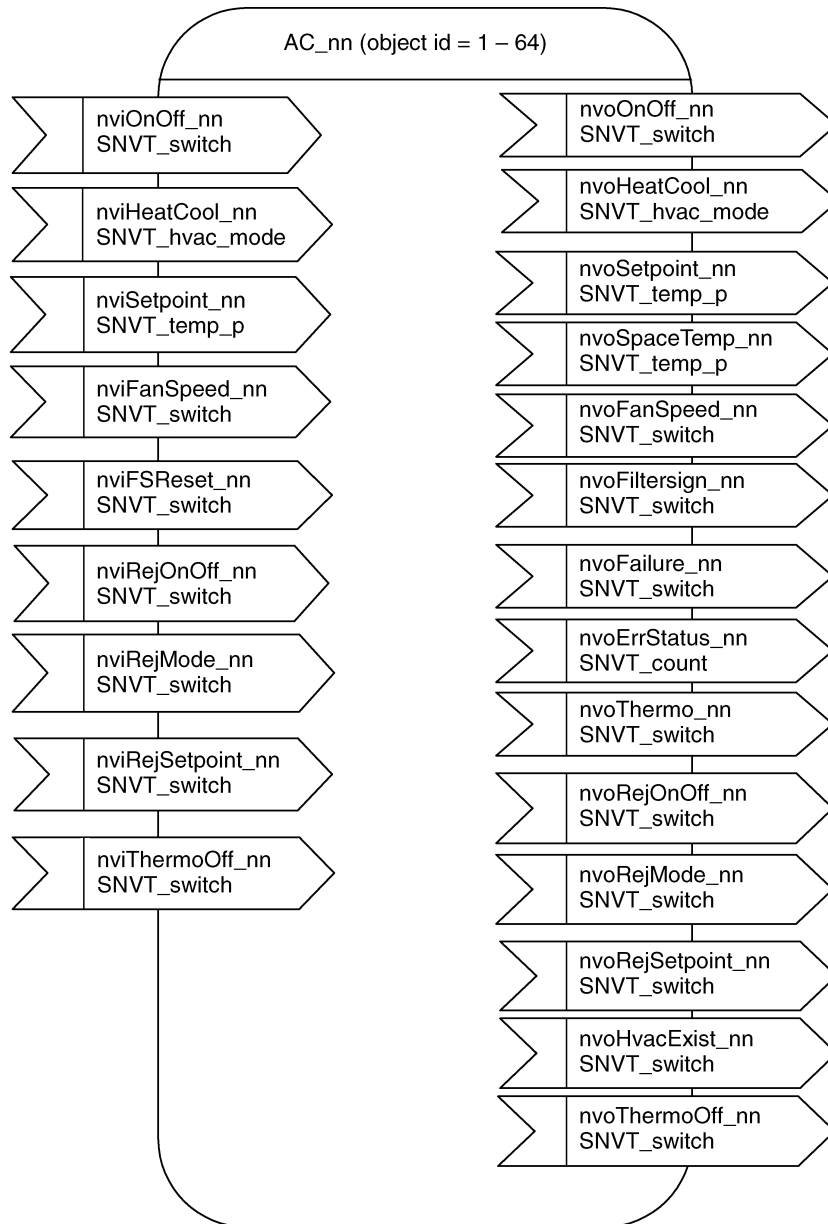

8. Details of Network Variables

8.1 Node Objects

1. Object Request Input (Node Request)

network input SNVT_obj_request nviRequest;

Valid Range

object_id :	0 - 65	0 = Node object, 1 - 64 = AC_01 - AC_64, 65 = GENERAL
	Other than above	Invalid

object_request :	RQ_NOEMAL	Returns the object to the normal condition
	RQ_UPDATE_STATUS	Request for information regarding the object status
	RQ_REPORT_MASK	Request for a report status bit mask
	Other than above	Invalid

Default Value

object_id = 0, object_request = RQ_NORMAL

2. Object Status Output (Object Status)

network output SNVT_obj_status nvoStatus;

Valid Range

object_id :	0 - 65	Returns Object IDs requested.
	Other than above	Invalid

invalid_id :	0	Represents that it is a valid ID.
	1	Represents that it is an invalid ID.

invalid_request :	0	Request for an object that is supported
	1	Request for an object that is not supported

report_mask :	0	It is not an RQ_REPORT_MASK request.
	1	Replies Support Bits in response to an RQ_REPORT_MASK request

Transmission Timing

It is output when an Object Request is input.

Default Service Type

Acknowledged

8.2 DIII-NET Common Objects

1. System Forced OFF Setting Input (System OFF)

network input SNVT_switch nviSystemOff;

This input network variable is used to forcibly stop/reset all indoor units connected to the LON Gateway. This forced OFF status differs from the normal OFF state in that the units cannot be started up via a remote controller or any other centralized device. Moreover, even when the forced OFF setting is reset, the A/C system does not return to the operation status prior to the OFF setting, but remains in the OFF status.

This function cannot be used when a forced OFF sign is input to the LON Gateway's contact points (T1 and T2) that are used for forced OFF.

Valid Range

Value	State	Indoor unit operation
Any (0 - 255)	0	Reset
0	1	Reset
1 - 255	1	Forced OFF

Default Value

After turning the LON adapter ON, the value remains at "0" until the communication with air conditioners is established.

2. Sub Group Address Control Operation Rejection Setting Input (Reject LC)

network input SNVT_switch nviRejLC;

This input network variable is used to permit/prohibit the operation of centralized devices on the DIII-NET.

Valid Range

Value	State	Indoor unit operation
Any (0 - 255)	0	Permitted
0	1	Permitted
1 - 255	1	Prohibited

Default Value

After turning the LON adapter ON, the value remains at "0" until updated.

3. System Forced OFF Status Output (System Forced OFF State)

network output SNVT_switch nvoSystemOff;

This output network variable indicates whether the system on the DIII-NET for the LON Gateway is in a System Forced OFF state.

Valid Range

Value	State	Indoor unit operation
0	0	Normal state
200	1	Forced OFF state

Transmission Timing

It is output when there is a change in the System Forced OFF status.

Update Interval

There is no function to regularly transmit the output variable.

Default Service Type

Acknowledged

4. Sub Group Address Control Operation Rejection Setting Output (Reject LC State)

network output SNVT_switch nvoRejLC;

This output network variable indicates whether the operation of centralized devices on the DIII-NET for the LON Gateway is permitted/prohibited.

Valid Range

Value	State	Indoor unit operation
0	0	Permitted
200	1	Prohibited

Transmission Timing

It is output when there is a change in the Sub Group Address Control Operation Rejection status.

Update Interval

There is no function to regularly transmit the output variable.

Default Service Type

Acknowledged

8.3 A/C Objects (AC_01 to AC_64)

1. ON/OFF Command Input (Start/Stop)

network input SNVT_switch nviOnOff_nn;

This input network variable is used to start/stop indoor units.

Value	State	Indoor unit operation
Any (0 - 255)	0	OFF
0	1	OFF
1 - 255	1	ON

Default Value

After turning the LON Gateway ON, the value and state remain at "0" until the communication with air conditioners is established.

2. Operation Mode Setting Input (Operating Mode)

network input SNVT_hvac_mode nviHeatCool_nn;

This input network variable is used to set the operation mode of the indoor unit(s).

The operation mode is valid only for indoor units that allow a selection between cooling and heating modes.

Valid Range

HVAC_AUTO : 0 = Auto
 HVAC_HEAT : 1 = Heating
 HVAC_COOL : 3 = Cooling
 HVAC_FAN_ONLY : 9 = Ventilation

Default Value

After turning the LON adapter ON, the value remains at "0" until the communication with air conditioners is established.

3. Temperature Setting Input (Setpoint)

This input network variable is used to set the temperature for the indoor unit(s). The range at which temperatures can be set differs with respect to whether it is for cooling operation or heating operation. Therefore, please be sure to confirm the operation mode before setting the temperature.

Valid Range

When cooling 20 to 35°C
 When heating 15 to 30°C
 Temperature setting increments: 0.1°C

Note:

The range at which the temperature can be set may differ depending on the model of the indoor and outdoor units. For details, please refer to the specifications of the air conditioners in use.

Default Value

After turning the LON adapter ON, the value remains at "0" until updated.

4. Airflow Rate Setting Input (Fan Speed)

network input SNVT_switch nviFanSpeed_nn;

This input network variable is used to set the airflow rate of the fan in the indoor unit(s).

Valid Range

Value	State	Indoor unit operation
1-100	1	Low
101-255	1	High

Default Value

After turning the LON adapter ON, the value remains at "0" until the communication with air conditioners is established.

5. Filter Sign Reset Input (Reset Filter Sign)

network input SNVT_switch nviFSReset_nn;

This input network variable is used to reset the filter sign when the filter sign on the indoor unit is malfunctioning.

Valid Range

Value	State	Indoor unit operation
0, 1	Any (0 - 255)	Reset

Default Value

After turning the LON adapter ON, the value remains at "0" until updated.

6. Forced Thermostat OFF Setting Input (Forced Thermo OFF)

network input SNVT_switch nviThermoOff_nn;

This input network variable is used to forcibly set/reset an OFF setting for the indoor unit thermostat operation.

Valid Range

Value	State	Indoor unit operation
Any (0 - 255)	0	Reset
0	1	Reset
1 - 255	1	OFF

Default Value

After turning the LON adapter ON, the value remains at "0" until updated.

7. Remote Control ON/OFF Operation Rejection Input (Reject RM Start/Stop)

network input SNVT_switch nviRejOnOff_nn;

This input network variable is used to set whether to permit/prohibit the ON/OFF operation of the indoor unit(s) from a remote controller.

Valid Range

Value	State	Indoor unit operation
Any (0 - 255)	0	Permitted
0	1	Permitted
1 - 255	1	Prohibited

Default Value

After turning the LON adapter ON, the value remains at "0" until the communication with air conditioners is established.

8. Remote Control Operation Mode Setting Rejection Input (Reject RM Mode)

network input SNVT_switch nviRejMode_nn;

This input network variable is used to permit/prohibit the setting of an indoor unit's operation mode from a remote controller.

Valid Range

Value	State	Indoor unit operation
Any (0 - 255)	0	Permitted
0	1	Permitted
1 - 255	1	Prohibited

Default Value

After turning the LON adapter ON, the value remains at "0" until updated.

9. Remote Control Temperature Setting Operation Rejection Input (Reject RM Setpoint)

network input SNVT_switch nviRejSetpoint_nn;

This input network variable is used to permit/prohibit the setting of an indoor unit's temperature value from a remote controller.

Valid Range

Value	State	Indoor unit operation
Any (0 - 255)	0	Permitted
0	1	Permitted
1 - 255	1	Prohibited

Default Value

After turning the LON adapter ON, the value remains at "0" until updated.

10.ON/OFF Status Output (OnOff State)

network output SNVT_switch nvoOnOff_nn;

This output network variable indicates the ON/OFF status of the indoor unit(s) at that time. However, it maintains an ON status if an error occurs in an air conditioner so that the system error reset can be conducted through an OFF command.

Valid Range

Value	State	Indoor unit operation
0	0	OFF
200	1	ON

After turning the LON adapter ON, the value and state remain at "0" until the communication with the MACSIV air conditioner is established.

Transmission Timing

It is output when there is a change in the ON/OFF status. It is also output when the ON/OFF status is changed by a remote controller or centralized device on the DIII-NET.

Update Interval

The value set at nciSndHrtBt takes effect.

Default Service Type

Acknowledged

11.Operation Mode Status Output (Operating Mode State)

network output SNVT_hvac_mode nvoHeatCool_nn;

This output network variable indicates the status of the indoor unit's operation mode.

When operation mode is set to "Auto", the output network returns the operation mode (either Heating, Cooling or Ventilation) at that time. If operation mode is set to "Dry" by a remote controller, it returns to "Cooling" mode.

Valid Range

HVAC_HEAT : 1 = Heating
 HVAC_COOL : 3 = Cooling
 HVAC_FAN_ONLY : 9 = Ventilation

After turning the LON adapter ON, the value and state remain at "0" until the communication with the MACSIV air conditioner is established.

Transmission Timing

It is output when there is a change in the Operation Mode status. It is also output when the Operation Mode status is changed by a remote controller or centralized device on the DIII-NET.

Update Interval

There is no function to regularly transmit the output variable.

Default Service Type

Acknowledged

12. Temperature Setting Status Output (Setpoint State)

network output SNVT_temp_p nvoSetpoint_nn;

This output network variable indicates the status of the temperature setting of the indoor unit(s) at that time.

Valid Range

When cooling 20 to 35°C

When heating 15 to 30°C

Temperature setting increments: 0.1°C

Note:

The range at which the temperature can be set may differ depending on the model of the indoor and outdoor units. For details, please refer to the specifications of the air conditioners in use.

Transmission Timing

It is output when there is a change in the room temperature setting status. It is also output when the temperature setting status is changed by a remote controller or centralized device on the DIII-NET.

Update Interval

There is no function to regularly transmit the output variable.

Default Service Type

Acknowledged

13. Room Temperature Status Output (Space Temperature State)

network output SNVT_temp_p nvoSpaceTemp_nn;

This output network variable indicates the temperature state of the indoor unit(s).

The temperature refers to either suction temperature or discharge temperature depending on the specific air conditioner model.

Valid Range

Output range -10 to +50°C

Temperature setting increments: 0.1°C

In the event of a sensor error, the temperature will be displayed as "327.67°C (Invalid)".

After turning the LON adapter ON, the value and state remain at "0" until the communication with the indoor units is established.

Transmission Timing

It is output when there is a change in room temperature.

Update Interval

The value set at nciSndHrtBt takes effect.

Default Service Type

Acknowledged

14. Airflow Rate Setting Status Output (Fan Speed State)

network output SNVT_switch nvoFanSpeed_nn;

This output network variable indicates the status of the airflow rate setting for the indoor unit(s) at that time.

Valid Range

Value	State	Indoor unit operation
100	1	Low
200	1	High

Note:

A/C units with 3 or more speeds (airflow rate) are also roughly classified into either "High" or "Low".

Transmission Timing

It is output when there is a change in the Airflow Rate Setting status. It is also output when the Airflow Rate Setting status is changed by a remote controller or centralized device on the DIII-NET.

Update Interval

There is no function to regularly transmit the output variable.

Default Service Type

Acknowledged

15. Filter Sign Status Output (Filter Sign State)

network output SNVT_switch nvoFiltersign_nn;

This output network variable indicates the status of the indoor unit's filter sign at the time.

Valid Range

Value	State	Indoor unit operation
0	0	No Filter Sign
200	1	Filter Sign

Transmission Timing

It is output when there is a change in the Filter Sign status.

Update Interval

The value set at nciSndHrtBt takes effect.

Default Service Type

Acknowledged

16. Error Status Output (Trip State)

network output SNVT_switch nvoFailure_nn;

This output network variable indicates the error state of the indoor unit(s) at that time. Even if one of the sub machines connected through a remote control group malfunctions, it is reported as an error in the main machine connected to the DIII-NET. Moreover, when sub machines in a remote control group are connected to the DIII-NET and either of them malfunctions, all of the indoor units within the remote control group are displayed as malfunctioning.

Valid Range

Value	State	Indoor unit operation
0	0	Normal
200	1	Error

Transmission Timing

It is output when there is a change in the error status.

Update Interval

The value set at nciSndHrtBt takes effect.

Default Service Type

Acknowledged

17. Error Code Output (Malfunction Code)

network output SNVT_counter nvoErrStatus_nn;

This output network variable indicates the details of error codes transmitted when an error occurs in an indoor unit.

Valid Range

0	No Error
1-23114	Error Code

Note:

These error codes are shown in a 2-character ASC decimal code specified by Daikin. The details are shown below.

Therefore, in order to understand an error code, after converting the output network variable to a hexadecimal, alter it into an ASCII code and then link the high and low bytes. Confirm the details of error codes obtained with Daikin's service divisions, or refer to the respective A/C service manual.

Transmission Timing

It is also output when there is a change in the error status if the A/C unit(s).

Update Interval

The value set at nciSndHrtBt takes effect.

Default Service Type

Acknowledged

18. Thermostat Status Output (Thermo State)

network output SNVT_switch nvoThermo_nn;

This output network variable indicates if the indoor unit is regulating the temperature (Thermo ON/OFF status).

Valid Range

Value	State	Indoor unit operation
0	0	Thermo OFF
200	1	Thermo ON

Transmission Timing

It is output when there is a change in the Thermo ON/OFF status.

Update Interval

There is no function to regularly transmit the output variable.

Default Service Type

Acknowledged

19. Forced Thermostat OFF Setting Status Output (Forced Thermo OFF State)

network output SNVT_switch nvoThermoOff_nn;

This output network variable indicates whether the Forced Thermo OFF Setting status is set or reset.

Valid Range

Value	State	Indoor unit operation
0	0	Reset
200	1	Set

Transmission Timing

It is output when there is a change in the Thermo ON/OFF Setting status.

Update Interval

There is no function to regularly transmit the output variable.

Default Service Type

Acknowledged

20.Remote Control ON/OFF Operation Rejection Output (Reject RM ON/OFF State)

network output SNVT_switch nvoRejOnOff_nn;

This output network variable indicates whether the ON/OFF operation of the indoor unit(s) is permitted or prohibited from a remote controller.

Valid Range

Value	State	Indoor unit operation
0	0	Permitted
200	1	Prohibited

Transmission Timing

It is output when there is a change in the Remote Control ON/OFF Operation Rejection status.

Update Interval

There is no function to regularly transmit the output variable.

Default Service Type

Acknowledged

21.Remote Control Operation Mode Setting Rejection Output (Reject RM Mode State)

network output SNVT_switch nvoRejMode_nn;

This output network variable indicates whether a setting of operation mode of the indoor unit(s) is permitted or prohibited from a remote controller.

Valid Range

Value	State	Indoor unit operation
0	0	Permitted
200	1	Prohibited

Transmission Timing

It is output when there is a change in the Remote Control Operation Mode Setting Rejection status.

Update Interval

There is no function to regularly transmit the output variable.

Default Service Type

Acknowledged

22.Remote Control Temperature Setting Operation Rejection Output (Reject RM Setpoint State)

network output SNVT_switch nvoRejSetpoint_nn;

This output network variable indicates whether the temperature setting operation for the indoor unit from a remote controller is permitted or prohibited.

Valid Range

Value	State	Indoor unit operation
0	0	Permitted
200	1	Prohibited

Transmission Timing

It is output when there is a change in the Remote Control Temperature Setting Operation Rejection status.

Update Interval

There is no function to regularly transmit the output variable.

Default Service Type

Acknowledged

23.A/C Connection Status Output (Communication State)

network output SNVT_switch nvoHvacExist_nn;

This output network variable indicates whether the connection status of the A/C unit(s).

Valid Range

Value	State	Indoor unit operation
0	1	No connection
1	1	Normal connection
2	1	Communication error

Transmission Timing

It is output when there is a change in the A/C Connection status.

Update Interval

The value set at nciSndHrtBt takes effect.

Default Service Type

Acknowledged

8.4 Configuration Properties

1. Transmission Interval Setting (Send Heartbeat)

network input config SNVT_time_sec nciSndHrtBt;

These configuration properties are used to set the transmission interval between two consecutive output network variables. This interval is regulated by the value for the transmission limit, nciMaxRng.

Applicable network variables are as follows:

nvoOnOff_nn (ON/OFF Status Output)
 nvoSpaceTemp_nn (Room Temperature Status Output)
 nvoFiltersign_nn (Filter Sign Status Output)
 nvoFailure_nn (Error Status Output)
 nvoErrStatus_nn (Error Code Output)
 nvoHvacExist_nn (A/C Connection Status Output)

Valid Range

0.0-1200.0 seconds

There is no regular transmission function if the value is 0.0 sec. However, communications with A/C units are conducted every 12 seconds so, even if transmission interval is set at less than 12 seconds, the value does not change.

Default Value

0.0 seconds (No regular transmission function)

2. Minimum Transmission Interval Setting (Minimum Send Time)

network input config SNVT_time_sec nciMinOutTm;

These configuration properties are used to set the minimum transmission interval between two consecutive output network variables.

Applicable network variables are as follows:

nvoOnOff_nn (ON/OFF Status Output)
 nvoHeatCool_nn (Operation Mode Status Output)
 nvoSetpoint_nn (Temperature Setting Status Output)
 nvoSpaceTemp_nn (Room Temperature Status Output)
 nvoFanSpeed_nn (Airflow Rate Setting Status Output)
 nvoFiltersign_nn (Filter Sign Status Output)
 nvoFailure_nn (Error Status Output)
 nvoErrStatus_nn (Error Code Output)
 nvoThermo_nn (Thermostat Status Output)
 nvoThermoOff_nn (Forced Thermostat OFF Status Output)
 nvoRejOnOff_nn (Remote Control ON/OFF Operation Rejection Output)
 nvoRejSetpoint_nn (Remote Control Operation Mode Operation Rejection Output)
 nvoRejSetpoint_nn (Remote Control Temperature Setting Operation Rejection Output)
 nvoSystemOff (System Forced OFF Status Output)
 nvoRejLC (Sub Group Address Control Operation Rejection Status Output)
 nvoHvacExist_nn (A/C Connection Status Output)

Valid Range

0.0-1200.0 seconds

There is no regular transmission function if the value is 0.0 sec.

Default Value

0.0 seconds (No minimum transmission interval control)

3. Detect Minimum Temperature Change Setting (Send on Delta Temperature)

network input config SNVT_temp_p nciMinDelta;

This configuration property represents an output network variable to be transmitted when there is a change in temperature that is greater than the specified value between two consecutive transmissions.

Applicable network variables are as follows:

nvoSpaceTemp_nn (Room Temperature Status Output)

Valid Range

0.10-10.00°C

Default Value

0.10°C

4. Transmission Start Delay Time Setting (Delay Start up Time)

network input config SNVT_time_sec nciStartUpDly;

These configuration properties are used to set the time lag between turning on the LON Gateway and starting the LON communications. This setting is useful for avoiding communication congestion when LON nodes on the network simultaneously start up.

Applicable network variables are as follows:

nvoOnOff_nn (ON/OFF Status Output)

nvoHeatCool_nn (Operation Mode Status Output)

nvoSetpoint_nn (Temperature Setting Status Output)

nvoSpaceTemp_nn (Room Temperature Status Output)

nvoFanSpeed_nn (Airflow Rate Setting Status Output)

nvoFiltersign_nn (Filter Sign Status Output)

nvoFailure_nn (Error Status Output)

nvoErrStatus_nn (Error Code Output)

nvoThermo_nn (Thermostat Status Output)

nvoThermoOff_nn (Forced Thermostat OFF Status Output)

nvoRejOnOff_nn (Remote Control ON/OFF Operation Rejection Output)

nvoRejSetpoint_nn (Remote Control Operation Mode Setting Rejection Output)

nvoRejSetpoint_nn (Remote Control Temperature Setting Rejection Output)

nvoSystemOff (System Forced OFF Status Output)

nvoRejLC (Sub Group Address Control Operation Rejection Status Output)

nvoHvacExist_nn (A/C Connection Status Output)

Valid Range

60.0-1200.0 seconds

Default Value

60.0 seconds (No minimum transmission interval control)

5. Maximum Transmission Limit Setting (Range Maximum)

network input config SNVT_count nciMaxRng;

These configuration properties represent output network variables and are used to set the number of messages transmitted per minute from the LON Gateway.

Applicable network variables are as follows:

nvoOnOff_nn (ON/OFF Status Output)
nvoHeatCool_nn (Operation Mode Status Output)
nvoSetpoint_nn (Temperature Setting Status Output)
nvoSpaceTemp_nn (Room Temperature Status Output)
nvoFanSpeed_nn (Airflow Rate Setting Status Output)
nvoFiltersign_nn (Filter Sign Status Output)
nvoFailure_nn (Error Status Output)
nvoErrStatus_nn (Error Code Output)
nvoThermo_nn (Thermostat Status Output)
nvoThermoOff_nn (Forced Thermostat OFF Status Output)
nvoRejOnOff_nn (Remote Control ON/OFF Operation Rejection Output)
nvoRejSetpoint_nn (Remote Control Operation Mode Setting Rejection Output)
nvoRejSetpoint_nn (Remote Control Temperature Setting Rejection Output)
nvoSystemOff (System Forced OFF Status Output)
nvoRejLC (Sub Group Address Control Operation Rejection Status Output)
nvoHvacExist_nn (A/C Connection Status Output)

Valid Range

0-6000 messages/sec.

No limitation in cases of 0.

Default Value

0 (No limit)

9. Precautions regarding XIF Files

9.1 File Name

DMS_IF02.XIF

9.2 Limitations with Version 3

Daikin's XIF file is written in the Version 3 format, and the default values for configuration properties (CP) are not written within the XIF file. Therefore, when using a LonMaker to add devices, be sure to conduct the procedures at the CP value of "Current values in device" and not that of "Default values in the XIF file".

9.3 Unused Network Variables

The network variables listed below do exist within our XIF file, but are not explained in these specifications. These are intended strictly for internal use and should not be used.

nvoWattmeter

nviSetTime

nvi SetNetDB

nvoSetNetDB

10. Notes for when Commissioning

10.1 Suspension of Message Transmission when Receiving Set Node Mode Online

The LON Gateway suspends spontaneous message transmission, such as reports of the bound output network variable changes and heartbeat, as well as responding to the Node Object, for one minute after receiving "Set Node Mode Online", a management message. However, it responds to other network management requests such as "poll" and "fetch". This function is a mechanism to prevent time out errors because of transmission of messages spontaneously issued by the LON Gateway when it comes online due to use of an installation tool such as the LonMaker during commissioning.

11. Reference Materials (Error Code Conversion Table)

Error code	Value (Decimal)	Error code	Value (Decimal)	Error code	Value (Decimal)	Error code	Value (Decimal)	Error code	Value (Decimal)
A0	16688	C0	17200	E0	17712	H0	18480	F0	17968
A1	16689	C1	17201	E1	17713	H1	18481	F1	17969
A2	16690	C2	17202	E2	17714	H2	18482	F2	17970
A3	16691	C3	17203	E3	17715	H3	18483	F3	17971
A4	16692	C4	17204	E4	17716	H4	18484	F4	17972
A5	16693	C5	17205	E5	17717	H5	18485	F5	17973
A6	16694	C6	17206	E6	17718	H6	18486	F6	17974
A7	16695	C7	17207	E7	17719	H7	18487	F7	17975
A8	16696	C8	17208	E8	17720	H8	18488	F8	17976
A9	16697	C9	17209	E9	17721	H9	18489	F9	17977
AA	16705	CA	17217	EA	17729	HA	18497	FA	17985
AH	16712	CH	17224	EH	17736	HH	18504	FH	17992
AC	16707	CC	17219	EC	17731	HC	18499	FC	17987
AJ	16714	CJ	17226	EJ	17738	HJ	18506	FJ	17994
AE	16709	CE	17221	EE	17733	HE	18501	FE	17989
AF	16710	CF	17222	EF	17734	HF	18502	FF	17990

Error code	Value (Decimal)	Error code	Value (Decimal)	Error code	Value (Decimal)	Error code	Value (Decimal)	Error code	Value (Decimal)
J0	18992	L0	19504	P0	20528	U0	21808	M0	19760
J1	18993	L1	19505	P1	20529	U1	21809	M1	19761
J2	18994	L2	19506	P2	20530	U2	21810	M2	19762
J3	18995	L3	19507	P3	20531	U3	21811	M3	19763
J4	18996	L4	19508	P4	20532	U4	21812	M4	19764
J5	18997	L5	19509	P5	20533	U5	21813	M5	19765
J6	18998	L6	19510	P6	20534	U6	21814	M6	19766
J7	18999	L7	19511	P7	20535	U7	21815	M7	19767
J8	19000	L8	19512	P8	20536	U8	21816	M8	19768
J9	19001	L9	19513	P9	20537	U9	21817	M9	19769
JA	19009	LA	19521	PA	20545	UA	21825	MA	19777
JH	19016	LH	19528	PH	20552	UH	21832	MH	19784
JC	19011	LL	19523	PP	20547	UC	21827	MC	19779
JJ	19018	LJ	19530	PJ	20554	UJ	21834	MJ	19786
JE	19013	LE	19525	PP	20549	UE	21829	ME	19781
JF	19014	LF	19526	PF	20550	UF	21830	MF	19782

Error code	Value (Decimal)	Error code	Value (Decimal)	Error code	Value (Decimal)	Error code	Value (Decimal)
30	13104	40	13360	50	13616	60	13872
31	13105	41	13361	51	13617	61	13873
32	13106	42	13362	52	13618	62	13874
33	13107	43	13363	53	13619	63	13875
34	13108	44	13364	54	13620	64	13876
35	13109	45	13365	55	13621	65	13877
36	13110	46	13366	56	13622	66	13878
37	13111	47	13367	57	13623	67	13879
38	13112	48	13368	58	13624	68	13880
39	13113	49	13369	59	13625	69	13881
3A	13121	4A	13377	5A	13633	6A	13889
3H	13128	4H	13384	5H	13640	6H	13896
3C	13123	4C	13379	5C	13635	6C	13891
3J	13130	4J	13386	5J	13642	6J	13898
3E	13125	4E	13381	5E	13637	6E	13893
3F	13126	4F	13382	5F	13638	6F	13894

Part 2

Control-related Design Keypoints

1. Introduction	28
2. System Configuration	29
2.1 A/C Units to be Monitored and Controlled	29
2.2 Number of A/C Units to be Monitored and Controlled	29
2.3 Location Address Setting and Combined Use of Other Centralized Devices	29
3. Hardware	31
3.1 Schematic Diagram of the Hardware	31
4. Outline of Functions	32
4.1 Outline of Function Via LON	32
4.2 Function of Contact Input	32
4.3 Control and Monitoring Items	33
4.4 Setting/Monitoring Restrictions from LON according to A/C Unit Model/Installation Method	36
5. LON Communication Specifications	37
5.1 LonMark Template Profiles	37
5.2 LonMark Certification	37
5.3 Object	37
5.4 Configuration Properties	37
6. Monitoring and Control Restrictions	39
6.1 Restrictions Regarding the 'System Forced OFF' Function	39
6.2 Operation Mode Changeover Restrictions	40
6.3 LON Address Table Restrictions	41
6.4 Suspension of Message Transmission when Receiving Set Node Mode Online	41
6.5 Group Binding Restrictions	41
6.6 Prohibition Time of Commands from LON (central monitoring panel) when Power is Restored after Power to A/C Units is Cut	41
6.7 Room Temperature Report	41
6.8 Change of Settings	41

1. Introduction

This document provides a general introduction to the specifications for the Interface for LONWORKS® linking Daikin's A/C control line (DIII-NET) with the LONWORKS network. The LONWORKS network via the Interface for LONWORKS® enables the monitoring and control of Daikin's VRV system.

2. System Configuration

2.1 A/C Units to be Monitored and Controlled

- VRV indoor units (H and K types)
- HRV (This refers to systems that are connectable to the DIII-NET. However, only On/Off operation can be monitored.)
- Sky Air indoor units (Each indoor unit requires an adapter to connect to the SkyAir. In cases of SkyAir, only main units are monitored and controlled.)
- RA (Adapters for the DIII-NET are necessary. However, only On/Off operation can be monitored.)
- General purpose adapter (DTA103A1: Only On/Off status can be monitored.)
- Centralized control adapter

2.2 Number of A/C Units to be Monitored and Controlled

A maximum of 64 groups of indoor units connected to a DIII-NET via one Interface for LONWORKS[®] are monitored and controlled. The indoor unit addresses from '1-00' to '4-15' correspond with the LON A/C numbers from 1 to 64 used in communications within the LON.

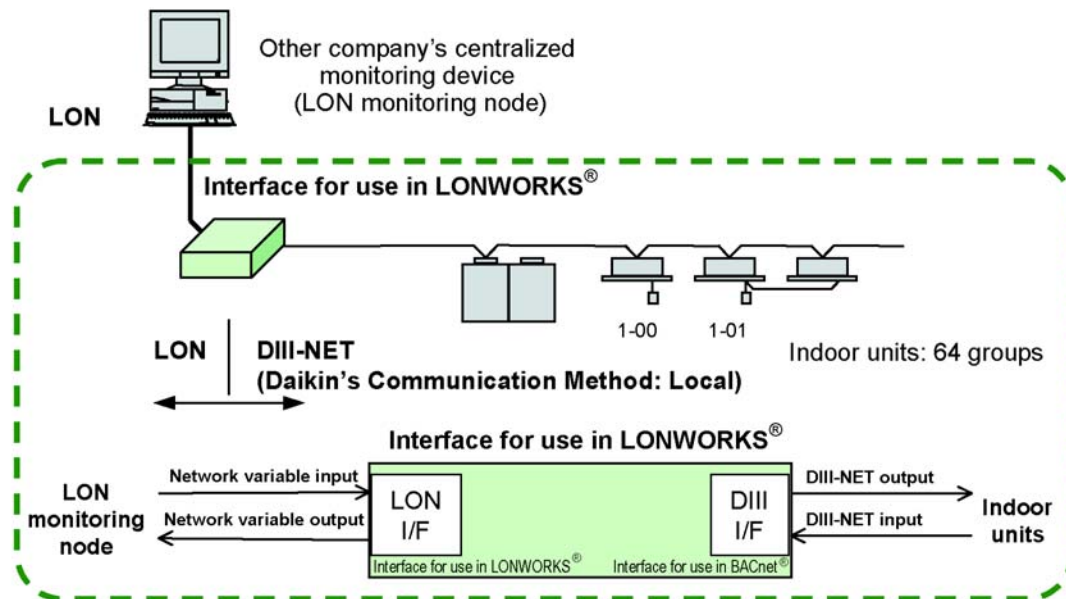

The above illustration was developed to provide a general image. The actual number of items controlled differs with respect to the number of indoor units connected. (The number increases/decreases according to the items being controlled.)

<Example> Control items: 20 ⇒ Number of units connected : 30
 Control items: 10 ⇒ Number of units connected : 60
 (20 acknowledged service items per second on a 30-second interval data collection cycle)
 Control items: 600 items

The number of units to be connected is determined according to the number of items that must be controlled.

2.3 Location Address Setting and Combined Use of Other Centralized Devices

- DDS, D-BIPS, Interface for BACnet Gateway and DMSII cannot be installed/used together on the same DIII-NET.
- Only one Interface for LONWORKS[®] can be installed on a DIII line.
- A Centralized Controller, intelligent Controller, ON/OFF Controller and Heat Storage Controller can be installed/used together.
 (The maximum number of groups that can be connected is 64, so there are restrictions on the number of centralized devices that can be connected.)
- A schedule timer cannot be installed/used together.
- The combined installation/use of a Centralized Controller and intelligent Controller is recommended to allow for independent centralized control if the LONWORKS system shuts down.

<Example>

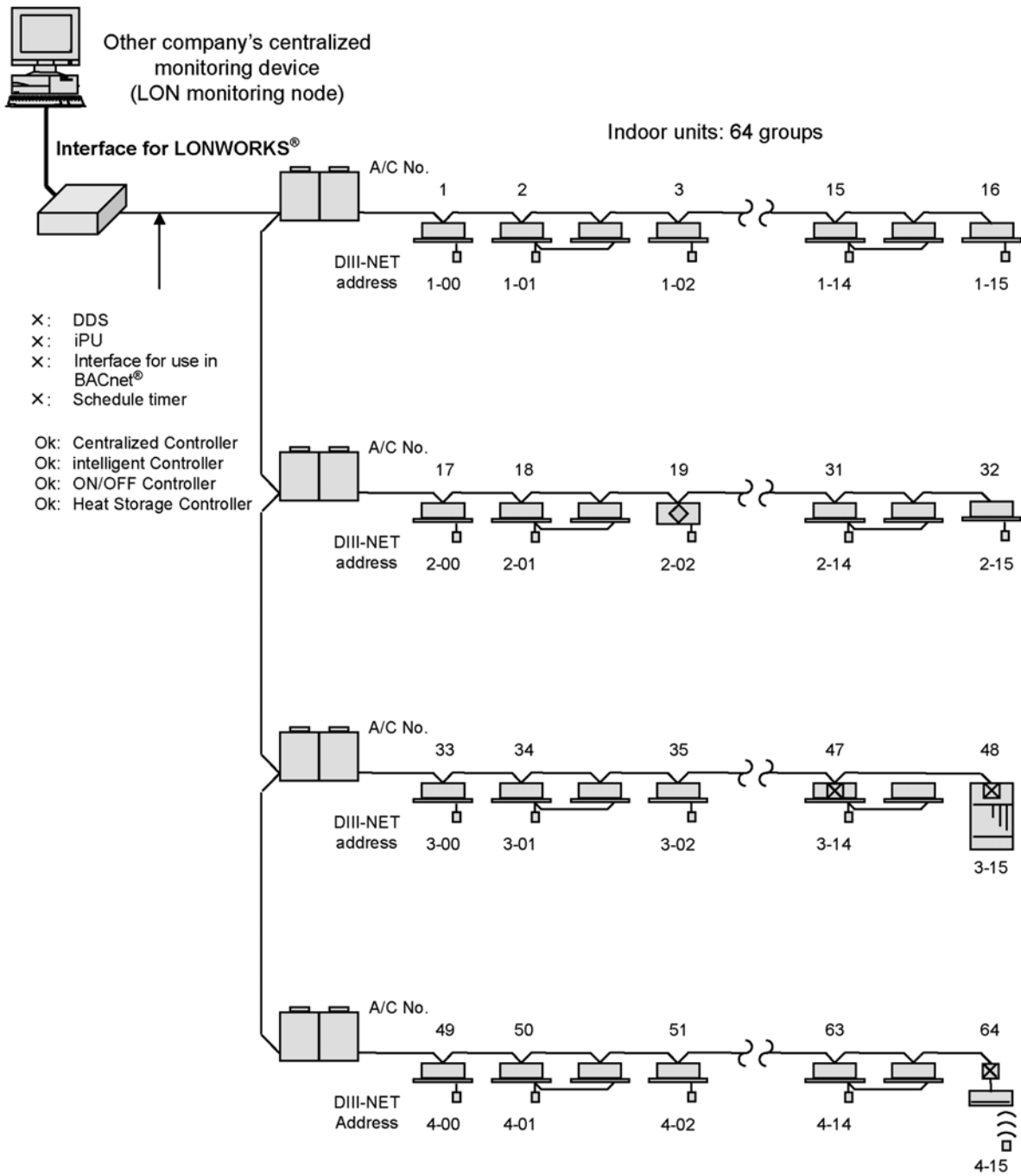

3. Hardware

3.1 Schematic Diagram of the Hardware

Power Source: 100 - 240 VAC

Surge killers and noise filters are unnecessary.

*See the official drawings for details.

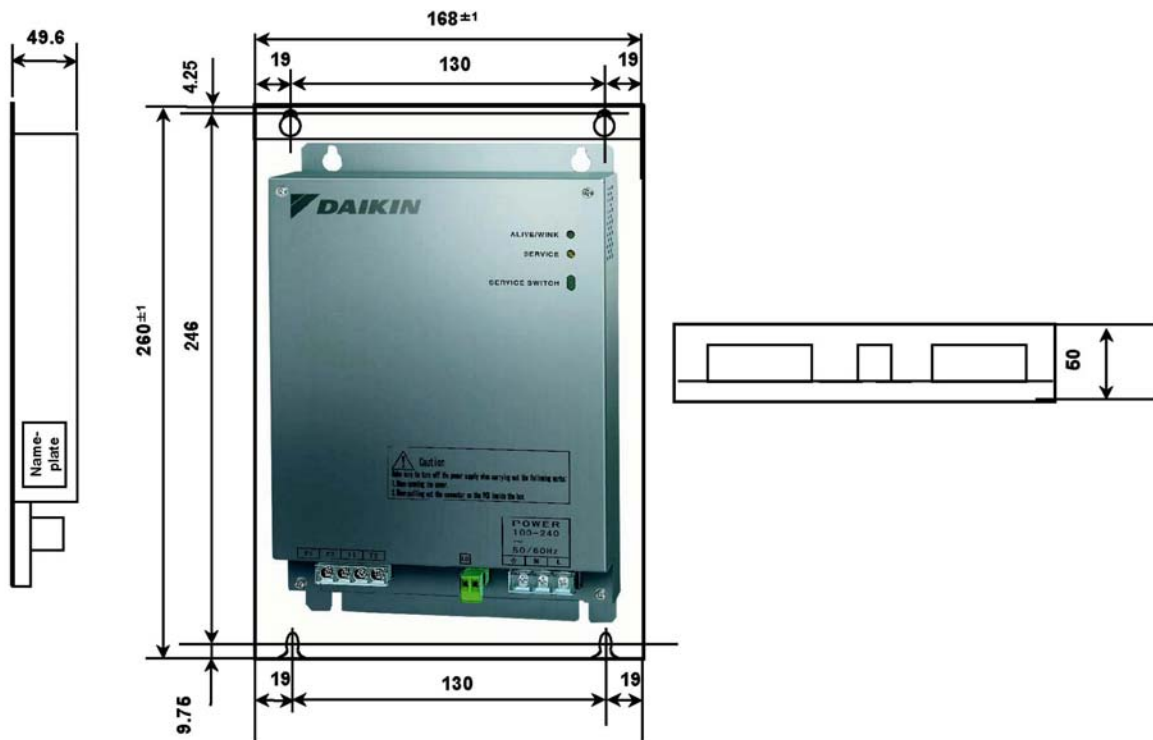

4. Outline of Functions

4.1 Outline of Function Via LON

(A) A/C unit control

The commands directed for each A/C unit are received from the LON monitoring node and commands are sent to the respective A/C units: Individual Control

The commands directed for all the A/C units on the respective DIII line are received from the LON monitoring node and the functions are executed: Batch Control

(B) A/C unit status monitoring

The A/C unit status is communicated to the LON monitoring node in the form of LON network variables.

(C) Report of A/C unit status change

When the status of an A/C unit changes, the respective value is sent to the LON monitoring node in the form of LON network variables (when output network variables are bound)

4.2 Function of Contact Input

(A) System Forced Off

The forced Off contact input enables batch forced Off control from the disaster prevention panel or the like.

Precautions:

Input of the forced Off takes one of the following forms:

- (1) Setting to 'nviSystemOff' from the LON monitoring node
- (2) Short circuit of the T1 and T2 terminals (Please use the microcurrent contact.)

4.3 Control and Monitoring Items

Control and monitoring items are shown below:

 Items pertaining to the entire system

	Function	Descriptions	Support
Control items *11	ON/OFF Command	Start/stop of A/C operation	Yes
	Operation Mode Setting	Heating/Cooling/Ventilation/Auto *1	Yes
	Temperature Setting	Set room temperature *2	Yes
	Airflow Rate Setting	Set airflow rate *3	Yes
	Filter Sign Reset	Filter sign reset *4	Yes
	Forced Thermostat OFF Setting	Forced thermostat OFF	Yes
	Remote ON/OFF Control Rejection	Permission/prohibition of ON/OFF operation *10	Yes
	Remote Operation Mode Control Rejection	Permission/prohibition of operation mode change *10	Yes
	Remote Temperature Setting Control Rejection	Permission/prohibition of set temp. change *10	Yes
	System Forced OFF Setting	System Forced OFF command	Yes
	Sub Group Address Control Rejection Setting	Sub Group Address Control Rejection command	Yes
Monitoring Items	ON/OFF Status Report	ON/OFF status *14	Yes
	Operation Mode Status Report	Heating/Cooling/Ventilation *5	Yes
	Temperature Setting Report	Set room temperature *2	Yes
	Room Temperature Report	Room temperature *2, *12, *16	Yes
	Airflow Rate Setting Report	Set airflow rate *3	Yes
	Filter Sign Report	Filter sign *6	Yes
	Error Status Report	Error status *7,*15	Yes
	Error Code Report	Error code *7	Yes
	Thermostat Status Report	Thermostat status	Yes
	Forced Thermostat OFF Setting Status Report	Forced thermostat OFF status	Yes
	Remote ON/OFF Operation Rejection Report	ON/OFF Operation Rejection Status *10	Yes
	Remote Operation Mode Setting Control Rejection Report	Operation Mode Setting Control Rejection status *10	Yes
	Remote Temperature Setting Control Rejection Report	Temperature Setting Control Rejection status *10	Yes
	System Forced OFF Setting Report	System Forced OFF Setting status (set or reset)	Yes
	Sub Group Address Control Operation Rejection Setting Report	Sub Group Address Control Operation Rejection Setting status (set or reset)	Yes
	A/C Communication Status Report	No Occupancy/ Communication normal/ Communication error *13, *15	Yes

- *1 Auto Mode settings directed for A/C units without a cooling/heating option will be read as a temperature control command. Therefore, the operation mode for these A/C units without the option are aligned with the operation mode for A/C units with the option.
- *2 The set room temperature for outdoor air treating A/Cs is represented by either the set or measured value of discharged air. (Does not apply to some models.)
- *3 Any airflow rates on the LON are classified either High or Low (only 2 speeds). In order to be used as DIII data, airflow rates of '4 or less' and '5 or more' are reread as 'Low' and 'High', respectively, for monitoring. In terms of commands, '1' is reread as 'Low' and '7' High.
- *4 Reset commands to the A/C units are issued/sent to the items displayed at that moment (filter or element).
- *5 The Auto Mode status cannot be monitored. 'Dry' operation is reported as cooling.
- *6 The OR status value for the filter sign and element sign.
- *7 An error is reported to the LON only when at or above abnormal levels. The error code is an ASCII 2 character and in an alarm form. Warning message is not reported.
- *10 Even for A/C units without R/Cs, this appears as if a 'Rejection' setting has been conducted.
- *11 The control commands sent to sub machines sub machines connected through a remote control group are ignored.
- *12 In cases of A/C units that are not equipped with a temperature sensor, the room temperature is reported as either 0°C or INVALID (0x7fff). (The value may differ from the actual room temperature depending on the location of the sensor.)
- *13 Communications errors are reported with novHvacExist_nn, nvoErrStatus_nn or nvoFailure_nn. Messages starting with nvo and ending with _nn maintain the latest value.
- *14 When an error occurs, the A/C unit stays in 'operation' status until the OFF command is sent from the R/C or main central monitoring panel.
- *15 U3 to U9 and UJ communication error messages are not sent within the first 5 minutes.
- *16 As the indoor fan stops when the operation is in special operation mode such as thermostat off, at rest or defrosting, the 'Room Temperature Report' is affected by the heat exchanger and the sensor may happen to detect the temperature different from that of the indoor and transmit the signal. Due to the above mentioned reason, consider the temperature as a rule of thumb. If the system control is to be based on this temperature (such as changeover of operation mode and changing the set temperature), the manufacturer of the building management system is kindly requested to carry out on its own responsibility.
- *17 The system is designed to keep the memory of the set conditions even when the air conditioner stops due to a power failure. Each time when the setting of temperature, ON / OFF, heat / cool mode, or air volume is changed, it is written into the non-volatile memory. The frequency of writing the setting into the non-volatile memory is limited and if the setting is frequently written into memory after exceeding the limit, it may cause malfunction. Therefore, **take caution so that the frequency of changing the setting of each indoor unit may not exceed 7000 times / year** when changing the setting of temperature, ON / OFF, heat / cool mode, or air volume frequently by automatic control or the like from the central monitoring panel.

<Additional Explanation>

- When the airflow rate for the Sky Air is changed to 'Medium' with 'Airflow Rate Setting Report' , it is monitored as 'Low' (anything below 4) because the 'Medium' command from the R/C is '3'.
- The operation mode during Auto Mode is monitored as either cooling, heating or ventilation.
- In terms of Error Status and Error Code monitoring, no message is sent/reported when the malfunction/error does not impede operation. (swing flap malfunctions, etc.)
- With regard to '*10. Even for A/C units without R/Cs, this appears as if a 'Rejection' setting has been conducted' , it would be meaningless and unlikely that a message prohibiting R/C operation would be sent to a A/C units that does not feature an R/C. However, if the LON monitoring node were to refer to a value, it would read the message as 'Control Rejection' setting.
- Out of the 27 items listed on the previous page, 23 are individual items and 4 are items pertaining to the entire system. Be sure to determine the contents and number of control items based on the selection from the 23 individual items.

<Rough Estimate of Number of Groups Connected >

Control and Monitoring Items n (individual groups)	Max. number of groups connected	Remarks
23 items (All)	13 groups	-One LON can monitor up to 300 items. -The maximum number of control and monitoring items is 23 per A/C unit. If the number of control and monitoring items per A/C unit is assumed as 'n', the number of A/C groups connectable would be: <div style="border: 1px solid black; padding: 2px; width: fit-content; margin: 10px auto;"> $\text{No. of A/C groups} \leq 300 \div n$ </div> <Note: The maximum No. of A/C groups is 64.>
20 items	15 groups	
18 items	16 groups	
16 items	18 groups	
15 items	20 groups	
12 items	25 groups	
10 items	30 groups	
4 items	64 groups	

(Assuming that acknowledged service is 10 items per second on a 30-second interval data collection cycle.)

- Acknowledged Service (possible communication volume): 10 items/second
This is one of the performance features of a Interface for LONWORKS®. It can process 10 items per second.
- 30-second interval data collection cycle
This is the time interval whereby device data (status) is collected from the central monitoring panel. In this case, the data regarding the connected A/C units is collected in 30 seconds. This figure differs with respect to the specifications of the central monitoring panel.
- Interface for LONWORKS® performance ...Acknowledged Service: 10 items/second (fixed value)
- Central Monitoring Panel performance...30-second data collection cycle
10 items per second being collected for 30 seconds translates into a total of 300 control items.
 $T = 10 \times 30 = 300$ items
Number of control items per group: Assuming the number of items per group is 23, the number of groups connectable is 13.
 $n = T \div (\text{No. of control items per group}) = 300 \div 23 = 13$ groups
- Interface for LONWORKS® performance ...Acknowledged Service: 10 items/second (fixed value)
- Central Monitoring Panel performance...60-second data collection cycle
10 items per second being collected for 60 seconds translates into a total of 600 control items.
 $T = 10 \times 60 = 600$ items
Number of control items per group: Assuming the number of items per group is 23, the number of groups connectable is 26
 $n = T \div (\text{No. of control items per group}) = 600 \div 23 = 26$ groups
- Interface for LONWORKS® performance ...Acknowledged Service: 10 items/second (fixed value)
- Central Monitoring Panel performance...120-second data collection cycle
10 items per second being collected for 120 seconds translates into a total of 1,200 control items.
 $T = 10 \times 120 = 1,200$ items
Number of control items per group: Assuming the number of items per group is 23, the number of groups connectable is 52
 $n = T \div (\text{No. of control items per group}) = 1,200 \div 23 = 52$ groups

4.4 Setting/Monitoring Restrictions from LON according to A/C Unit Model/ Installation Method

- Operation mode changeover commands directed to A/C units without a cooling/heating option are ignored. If the same command is sent to A/C units with the option, the operation mode of subordinate A/C units (without the option) may be changed over even if there is no direct instruction.
- When A/C units without Auto Mode are set on Auto, the Auto Mode (message) is ignored and the temperature control mode at that moment is maintained.
- BS units are not handled in any special manner.
- When sub A/C unit within a remote control group have a location address, they are monitored as one A/C unit. However, all commands directed to these A/C units are ignored.
- Upon the occurrence of an error within a remote control group, the Interface for LONWORKS® reports as follows:
 - (1) In cases where only the main A/C units within a remote control group have location addresses:

When any of the indoor units within the group malfunctions, the respective message is sent to the LON monitoring node in the form of the A/C number of the main A/C unit. In other words, if any of the A/C units within the group malfunctions, the message is output. However, the LON cannot recognize in which unit the error is occurring.
 - (2) In cases where all the indoor units within an remote control group have location addresses:

When any of the units within a group malfunctions, the corresponding message is sent to the LON monitoring node in the form of the A/C numbers of all main and sub A/C units within the group. In other words, if any one of the A/C units within the group malfunctions, the message is sent reporting all A/C numbers within the group; once again the LON cannot recognize in which unit the error is occurring.

However, this can be confirmed on a hand-held remote controller.
- When the A/C units and HRV are being controlled as a remote control group, the HRV cannot be independently operated by the central monitoring panel.
(If the independent operation command is sent to the HRV with a remote controller, the operation mode becomes 'ventilation'.)

5. LON Communication Specifications

5.1 LonMark Template Profiles

There are no LonMark Template Profiles created by the LonMark Association for the VRV. Therefore, original specifications for the VRV have been created without using the LonMark Template Profiles. These original specifications conform to standard network variable types established by the JRAIA.

5.2 LonMark Certification

The network variable types are original, so are not LonMark certified.

5.3 Object

There are 66 objects: **Node Object, General and A/C 01-A/C 64.**

The network variables regarding the

- Node Object: Lon monitoring node
 - General: All A/C units in the DIII system
 - A/C 01-A/C 64: Each of the A/C units in the DIII system
- are all provided around the Interface for LONWORKS®.

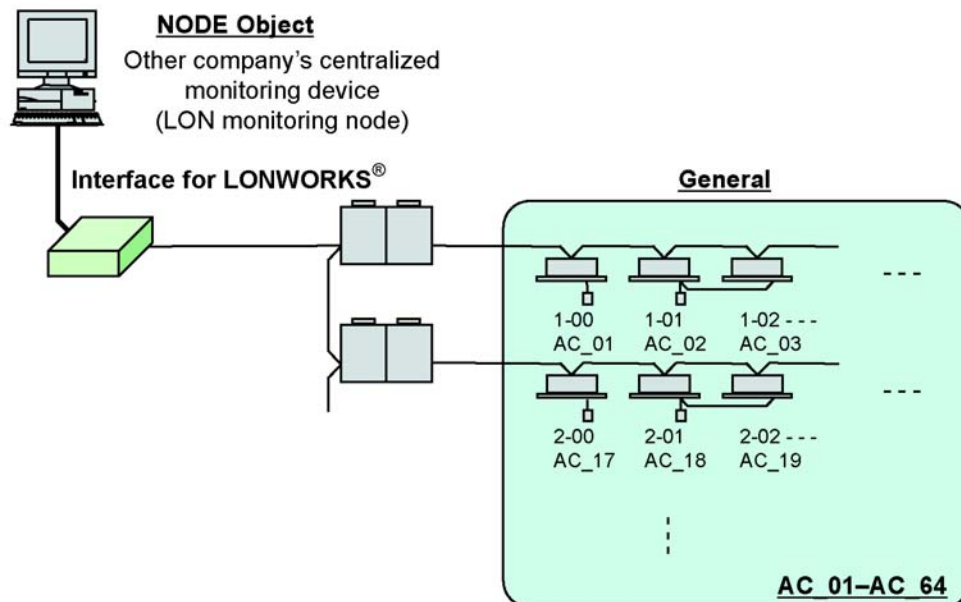

5.4 Configuration Properties

(1) Minimum Send Time: Minimum Transmission Interval

The bound output network variables will not be sent until the minimum transmission interval has passed even if there is a change in status value.

(When status is monitored, data regarding each status change is not sent upon each change but at minimum transmission intervals.)

(2) Send Heartbeat: Heartbeat Transmission

The bound output network variables will be sent to notify the system once the minimum transmission interval has passed even if there is no change in status value. The actual interval between transmitted messages will depend upon factors such as the transmission capacity of the Interface for LONWORKS® and the network traffic status (the relative volume of messages on the network).

The monitoring items to be sent are bound **On/Off Status Report, Room Temperature Report, Filter Sign Report, Error Status Report, Error Code Report and A/C Communication Status Report.**

(3) Send on Delta Temperature: Detect Minimum Temperature Change

The bound output network variables will be sent to notify the system when there is a change in temperature that is greater than the above specified value between two consecutive transmissions.

(4) Delay Start Up: Transmission Start Delay Time after Start Up

The time lag between turning on the LON node and starting the LON communications. This setting is useful for avoiding communication congestion when LON nodes on the network simultaneously start up.

(5) Range Maximum: Maximum Transmission Limit

The number of messages transmitted from the Interface for LONWORKS® will effectively be controlled by the bound output network variables. It also specifies the number of messages to be sent per minute. This is used to limit the number of messages to be consecutively sent from the nodes when they are started up.

Control items		Values and meanings
Minimum Transmission Interval	sec.	0 seconds and 1.0-1200.0 seconds 0: No control, Default Value: 0
Heartbeat Transmission	sec.	0 seconds and 10.0-1200.0 0: No control, Default Value: 0
Detect Minimum Temperature Change	°C	Temp. (°C): 0.10-10.00, Default Value: 0.10
Transmission Start Delay Time after Start Up	sec.	60.0-1200.0, Default Value: 60.0
Maximum Transmission Limit (messages/sec.)	--	0 and 1-6000, 0: No control, Default Value: 0

- Items to be transmitted are the following 6 items: **On/Off Status, Room Temperature, Filter Sign, Error Status, Error Code and A/C Communication Status.**
- The Interface for LONWORKS® collects room temperature data every 12 seconds, so any heartbeat transmission set at a lower time interval will ultimately result in a 12-second transmission interval.

6. Monitoring and Control Restrictions

6.1 Restrictions Regarding the 'System Forced OFF' Function

- The LON monitoring nodes send a 'System Forced OFF' command to the Interface for LONWORKS®.



All of the A/C units on the DIII-NET controlled by the Interface for LONWORKS® stop operating.

- A/C units cannot be operated from the hand-held remote controller.
 - A/C units cannot be operated from the centralized devices.
- The LON monitoring nodes send a message to deactivate the 'System Forced OFF' command to the Interface for LONWORKS®.



The system still cannot be operated.

All of the A/C units on the DIII-NET controlled by the Interface for LONWORKS® can be operated. (allow use of a remote controller)

- A/C units can be operated from the hand-held remote controller. (status is not restored)
 - A/C units can be operated from the centralized devices. (status is not restored)
- When the System Forced OFF command is issued, the hand-held remote controller for the A/C units becomes 'Inoperable status'. However, the output message of Remote ON/OFF Operation Rejection Report is not sent to the LON monitoring nodes.
The System Forced OFF status is output as a '**System Forced OFF Setting Report**'.
 - There is one System Forced OFF contact point per A/C control network (DIII-NET) line. Input in the Interface for LONWORKS® is conducted either contact input or via the LON. Moreover, the centralized device for the System Forced OFF input point is set as the DIII main A/C unit.
 - When the System Forced OFF Reset command and A/C Operation command from the LON monitoring nodes are sent at, more or less, the same time, the latter may not be properly sent to the A/C units. The entire A/C control network (DIII-NET) controlled by the Interface for LONWORKS® becomes System Forced OFF reset status, so the operation command for the A/C units may be rejected. If the A/C Operation command is to be sent after deactivation (reset), it is recommended that it be issued after confirming that the System Forced OFF has actually been deactivated (reset).
LON communications do not and cannot guarantee the startup order of processing when more than one status change are reported.

6.2 Operation Mode Changeover Restrictions

- When the Operation Mode Changeover command and Temperature Setting command from the LON monitoring nodes are sent at, more or less, the same time, the latter may not be properly sent to the A/C units.

<Example>

1. Changeover command from cooling to heating
2. Temperature Setting command in the heating mode: Change to 20 °C
3. Completion of temperature setting at 20 °C in the heating mode



1. Set temperature is changed first: Change to a 20°C in the cooling mode
2. Changeover from cooling to heating
3. Completion of temperature setting at the default value (initially set temperature) in the heating mode

It is recommended that the commands to change the set temperature be issued after confirming the Operation Mode Changeover command has actually been sent and processed.

LON communications do not and cannot guarantee the startup order of processing when more than one status change are reported.

6.3 LON Address Table Restrictions

- The entry numbers in the address tables used to bind the network variables are limited to a maximum of 15. This must be taken into consideration when using several parameters upon binding.

6.4 Suspension of Message Transmission when Receiving Set Node Mode Online

- The Interface for LONWORKS® suspends spontaneous message transmission, such as reports of the bound output network variable changes and heartbeat, as well as responding to the Node Object, for one minute after receiving "Set Node Mode Online", a management message. However, it responds to other network management requests such as "poll" and "fetch". This function is a mechanism to prevent time out errors because of transmission of messages spontaneously issued by the Interface for LONWORKS® when it comes online due to use of an installation tool such as the LonMaker during commissioning.

6.5 Group Binding Restrictions

- It is impossible to bind one of the LON monitoring node output network variables and more than one input network variable in the Interface for LONWORKS®. For example, setting one of the output networks of the monitoring node at 'ON' cannot turn the A/C units in the 10 groups under the LON monitoring node 'ON'. This restriction is based on the LON regulations.

6.6 Prohibition Time of Commands from LON (central monitoring panel) when Power is Restored after Power to A/C Units is Cut

- After restoration of electrical power that was cut to A/C units, commands must be sent from the LON (central monitoring panel) at least 5 or so minutes after the restoration. A/C communications are initialized for approximately 5 minutes upon power restoration and, thus, the A/C units will not receive any commands from the LON during this time period.

6.7 Room Temperature Report

As the indoor fan stops when the operation is in special operation mode such as thermostat off, at rest or defrosting, the 'Room Temperature Report' is affected by the heat exchanger and the sensor may happen to detect the temperature different from that of the indoor and transmit the signal.

Due to the above mentioned reason, consider the temperature as a rule of thumb. If the system control is to be based on this temperature (such as changeover of operation mode and changing the set temperature), the manufacturer of the building management system is kindly requested to carry out on its own responsibility.

6.8 Change of Settings

The system is designed to keep the memory of the set conditions even when the air conditioner stops due to a power failure. Each time when the setting of temperature, ON / OFF, heat / cool mode, or air volume is changed, it is written into the non-volatile memory. The frequency of writing the setting into the non-volatile memory is limited and if the setting is frequently written into memory after exceeding the limit, it may cause malfunction.

Therefore, **take caution so that the frequency of changing the setting of each indoor unit may not exceed 7000 times / year** when changing the setting of temperature, ON / OFF, heat / cool mode, or air volume frequently by automatic control or the like from the central monitoring panel.

Part 3

Check Sheet for Control and Monitoring Items

1. Workflow	44
2. Check Sheet for Control and Monitoring Items	45

1. Workflow

Workflow

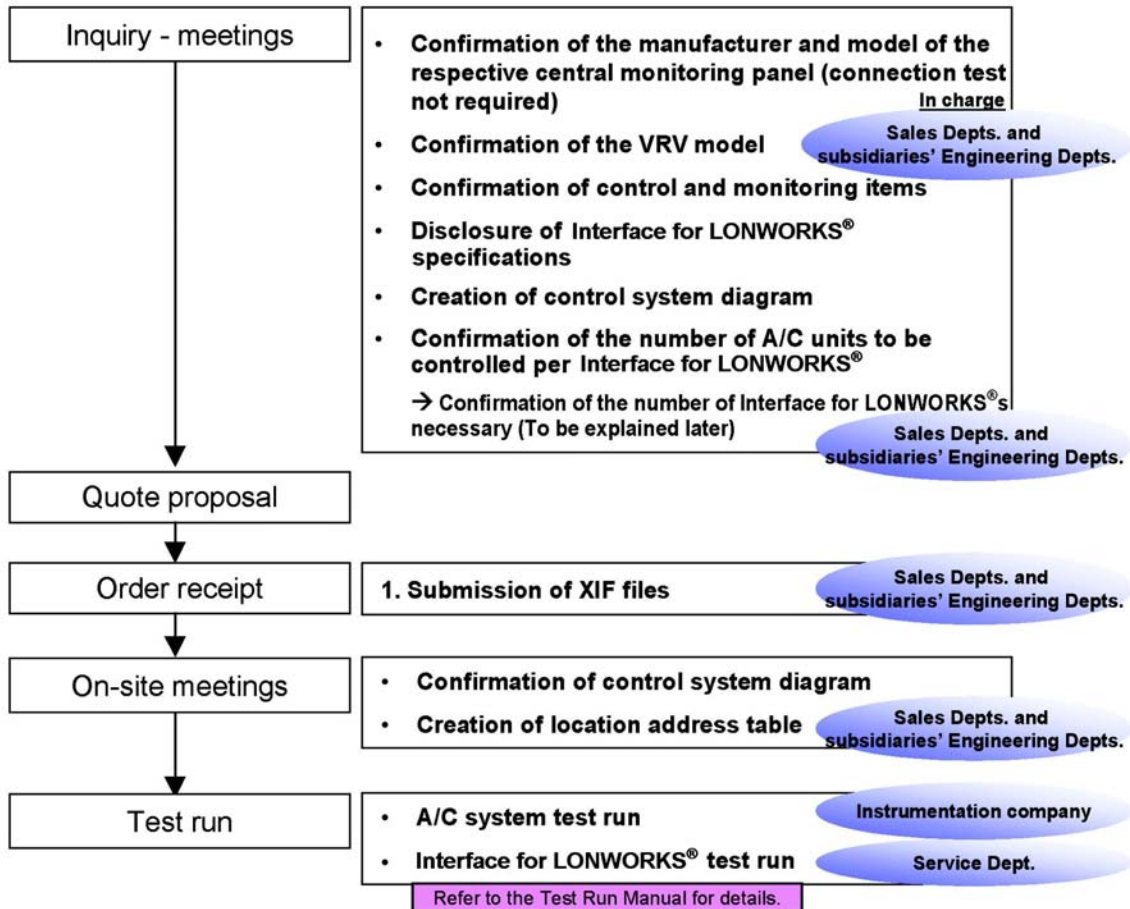

2. Check Sheet for Control and Monitoring Items

<Central monitoring panel specifications>

- Manufacture: _____

- Model: _____

Connection test not necessary.

The respective XIF file will be submitted based on your order.

<Address to which the XIF file is sent> It will be sent via e-mail.

- Company name: _____

- Department: _____

- Name: _____

- Phone: _____

- Fax: _____

- e-mail address: _____

Control and monitoring items are shown below:

Items pertaining to the entire system

	Function	Descriptions	Support	Needs
Control items *11	ON/OFF Command	Start/stop of A/C operation	Yes	
	Operation Mode Setting	Heating/Cooling/Ventilation/Auto *1	Yes	
	Temperature Setting	Set room temperature *2	Yes	
	Airflow Rate Setting	Set airflow rate *3	Yes	
	Filter Sign Reset	Filter sign reset *4	Yes	
	Forced Thermostat OFF Setting	Forced thermostat OFF	Yes	
	Remote ON/OFF Control Rejection	Permission/prohibition of ON/OFF operation *10	Yes	
	Remote Operation Mode Control Rejection	Permission/prohibition of operation mode change *10	Yes	
	Remote Temperature Setting Control Rejection	Permission/prohibition of set temp. change *10	Yes	
	System Forced OFF Setting	System Forced OFF command	Yes	
	Sub Group Address Control Rejection Setting	Sub Group Address Control Rejection command	Yes	
Monitoring Items	ON/OFF Status Report	ON/OFF status *14	Yes	
	Operation Mode Status Report	Heating/Cooling/Ventilation *5	Yes	
	Temperature Setting Report	Set room temperature *2	Yes	
	Room Temperature Report	Room temperature *2, *12, *16	Yes	
	Airflow Rate Setting Report	Set airflow rate *3	Yes	
	Filter Sign Report	Filter sign *6	Yes	
	Error Status Report	Error status *7, *15	Yes	
	Error Code Report	Error code *7	Yes	
	Thermostat Status Report	Thermostat status	Yes	
	Forced Thermostat OFF Setting Status Report	Forced thermostat OFF status	Yes	
	Remote ON/OFF Operation Rejection Report	ON/OFF Operation Rejection Status *10	Yes	
	Remote Operation Mode Setting Control Rejection Report	Operation Mode Setting Control Rejection status *10	Yes	
	Remote Temperature Setting Control Rejection Report	Temperature Setting Control Rejection status *10	Yes	
	System Forced OFF Setting Report	System Forced OFF Setting status (set or reset)	Yes	
	Sub Group Address Control Operation Rejection Setting Report	Sub Group Address Control Operation Rejection Setting status (set or reset)	Yes	
	A/C Communication Status Report	No Occupancy/ Communication normal/ Communication error *13, *15	Yes	
				Individual group
			Entire system	items

Note: Refer to the 'Function List by Model' regarding items for each series.

- *1 Auto Mode settings directed for A/C units without a cooling/heating option will be read as a temperature control command. Therefore, the operation mode for these A/C units without the option are aligned with the operation mode for A/C units with the option.
- *2 The set room temperature for outdoor air treating A/Cs is represented by either the set or measured value of discharged air. (Does not apply to some models.)
- *3 Any airflow rates on the LON are classified either High or Low (only 2 speeds). In order to be used as DIII data, airflow rates of '4 or less' and '5 or more' are reread as 'Low' and 'High', respectively, for monitoring. In terms of commands, '1' is reread as 'Low' and '7' High.
- *4 Reset commands to the A/C units are issued/sent to the items displayed at that moment (filter or element).
- *5 The Auto Mode status cannot be monitored. 'Dry' operation is reported as cooling.
- *6 The OR status value for the filter sign and element sign.
- *7 An error is reported to the LON only when at or above abnormal levels. The error code is an ASCII 2 character and in an alarm form. Warning message is not reported.
- *10 Even for a/c units without R/Cs, this appears as if a 'Rejection' setting has been conducted.
- *11 The control commands sent to sub units sub units connected through a remote control group are ignored.
- *12 In cases of units that are not equipped with a temperature sensor, the room temperature is reported as either 0°C or INVALID (0x7fff). (The value may differ from the actual room temperature depending on the location of the sensor.)
- *13 Communications errors are reported with novHvacExist_nn, nvoErrStatus_nn or nvoFailure_nn. Messages starting with nvo and ending with _nn maintain the latest value.
- *14 When an error occurs, the A/C unit stays in 'operation' status until the OFF command is sent from the R/C or main central monitoring panel.
- *15 U3 to U9 and UJ communication error messages are not sent within the first 5 minutes.
- *16 As the indoor fan stops when the operation is in special operation mode such as thermostat off, at rest or defrosting, the 'Room Temperature Report' is affected by the heat exchanger and the sensor may happen to detect the temperature different from that of the indoor and transmit the signal.
Due to the above mentioned reason, consider the temperature as a rule of thumb. If the system control is to be based on this temperature (such as changeover of operation mode and changing the set temperature), the manufacturer of the building management system is kindly requested to carry out on its own responsibility.

*17 The system is designed to keep the memory of the set conditions even when the air conditioner stops due to a power failure. Each time when the setting of temperature, ON / OFF, heat / cool mode, or air volume is changed, it is written into the non-volatile memory. The frequency of writing the setting into the non-volatile memory is limited and if the setting is frequently written into memory after exceeding the limit, it may cause malfunction. Therefore, **take caution so that the frequency of changing the setting of each indoor unit may not exceed 7000 times / year** when changing the setting of temperature, ON / OFF, heat / cool mode, or air volume frequently by automatic control or the like from the central monitoring panel.

<Rough Estimate of Number of Groups Connected >

Control and Monitoring Items n (individual groups)	Max. number of groups connected	Remarks
23 items (All)	26 groups	-One LON can monitor up to 600 items. -The maximum number of control and monitoring items is 23 per A/C unit. If the number of control and monitoring items per A/C unit is assumed as 'n', the number of A/C groups connectable would be: <div style="border: 1px solid black; padding: 5px; width: fit-content; margin: 10px auto;"> $\text{No. of A/C groups} \leq 300 \div n$ </div> <Note: The maximum No. of A/C groups is 64.>
20 items	30 groups	
18 items	33 groups	
16 items	37 groups	
15 items	40 groups	
12 items	50 groups	
10 items	60 groups	
9 items	64 groups	

(Assuming that acknowledged service is 20 items per second on a 30-second interval data collection cycle.)

- Acknowledged Service (possible communication volume): 20 items/second
This is one of the performance features of a Interface for LONWORKS®. It can process 20 items per second.
- 30-second interval data collection cycle
This is the time interval whereby device data (status) is collected from the central monitoring panel. In this case, the data regarding the connected A/C units is collected in 30 seconds. This figure differs with respect to the specifications of the central monitoring panel.
- Interface for LONWORKS® performance...Acknowledged service: 20 items per second (fixed value)
- Central Monitoring Panel performance...Data collection cycle interval: _____ seconds
(30 seconds when not specified.)

Data is collected 20 items per second for _____ seconds. Therefore, the total number of control items is calculated in a following manner:

$$T = 20 \times \text{_____} = \text{_____} \text{ items}$$

If the number of control items per group is _____, the number of groups connectable is:

$$n = T \div (\text{No. of control items per group}) = \text{_____} \div \text{_____} = \text{_____} \text{ groups}$$

<Maximum of 64 groups>

Part 4

Open Network Glossary

1. Open Network Glossary50

1. Open Network Glossary

Term	Explanation
ANSI	American National Standards Institute
ASHRAE	American Society of Heating, Refrigeration and Air-Conditioning Engineers, Inc.
BACnet	Building Automation Control Network
BAS	Building Automation System
BMS	Building Management System Refers to a system for building management (management of electricity charges, equipment and the like). BASs are configured within BMSs. Well known BMS manufacturers in Japan include NEC, YBS, YJ, Fujitsu, Panasonic and Oki.
DIIII-NET	Refers to Daikin Industries original communication network for A/C communications. (closed network)
Echelon	The U.S. company that developed the LON.
HIM	Human Interface Module A device that incorporates the concept of the standard BAS protocol supported by the Institute of Electrical Installation Engineers of Japan (IEIEJ). It enables the setting of parameters for status display, control and monitoring of building equipment. It refers to a human interface device that performs On/Off operations and the like.
Icont	Intelligent Controller A device that incorporates the concept of the standard BAS protocol supported by the IEIEJ. It is a control device that is connected to either the building equipment or devices targeted for control via an interface. It refers to a device that can support functions of independent monitoring, control and the like.
I/O	INPUT/OUTPUT Examples: Di (Digital input), Do (Digital output), Ai (Analog input), Ao (Analog output)
LON	Local Operating Network Refers to an intelligent distributed control network developed by the U.S. company, Echelon.
LONMAKER	Refers to the Echelon-developed tool (software) that allows installation commissioning (addressing), variable binding, variable browsing (monitoring) and the like.
LONMARK	The logo for products manufactured according to the guidelines established by the LONMARK Association.
LONMARK	Refers to the LONMARK Interoperability Association. The LONMARK Association is a nonprofit organization established to promote the use of LONWORKS. It consists of some 350 companies from all over the world, including 19 from Japan. The LONMARK Association was formed in order to create standard specifications for connection to LONs between different vendors (companies).
LONTALK	Refers to the protocol used in LONs.
LONWORKS	The generic term used to refer to the hardware, software, protocol and the like used to design, configure and manage/service LONs.

Term	Explanation
NI	<p>The acronym for Network Integrator.</p> <p>In the narrow sense, NI is the term used to refer to companies that have signed an NI contract with ECHELON. In the broad sense, NI is the generic term used to refer to companies and engineers that configure LONWORKS system networks proposed by ECHELON. The work of an NI is included in that of an SI (system integrator) or SE (system engineer) in the case of computer systems. In LONWORKS systems, the work of an NI involves network topology and network.</p>
NI companies in Japan	<p>Obayashi Corporation Takasago Thermal Engineering Co., Ltd. DAI-DAN Co., Ltd. NTT DATA Corporation Hitachi Plant Engineering & Construction Co., Ltd. Shimizu Corporation Yukoukeisou Co., Ltd. Chiyoda Keiso Co., Ltd. System instrumentation Co., Ltd. Hibiya Engineering, Ltd. Shinryo Corporation Mita Engineering Co., Ltd. Taikisha Ltd. Creight Co., Ltd. Kyowa Exeo Corporation As of August 2001</p>
nvi	Network Variable Input
nvo	Network Variable Output
SE	<p>System Engineer</p> <p>System Engineer (SE) is a generic term used in the computer industry to refer to engineers who install computers and communications devices for end-users. System engineers also generally confirm proper operation of OS (operating software) and AS (application software) after set up. These capabilities are, of course, necessary in the case of a BAS, but unlike the so-called computer systems, the SE must also determine necessary specifications in order for vendors to manufacture systems that can effectively realize functions and achieve desired performance levels detailed on the provided drawings. In addition, appropriate instruction to and/or coordination between related parties, such as departments that design and create hardware and software, according to the pertinent process as well as the promotion of smooth system configurations are also responsibilities of the SE.</p>
SI	<p>System Integrator</p> <p>System Integrator (SI) is a generic term used in the computer industry to refer not only to the work of selecting hardware and software suited to configured computer systems, setting up networks and altering software to accompany the systems to be installed but also to the companies/engineers who perform the work. BASs, including building management systems, represent a type of computer system, so the responsibilities of an SI are the same. In addition, the responsibilities of the SI also include: a thorough understanding of functions and features of the targeted electric equipment, A/C system and the like; coordination between hardware, software and network designs provided by a multiple number of vendors; and smooth configuring of systems to meet the objectives within a predetermined cost in cooperation with design supervisors and BA orderers.</p>
SNVT	<p>Standard Network Variable Types</p> <p>Refers to the variables used to control A/C units within LONs. These variables have been established by the The Japan Refrigeration and Air Conditioning Industry Association (JRAIA) and are the standard variables in Japan.</p> <p>They are the equivalent of codes for control and monitoring items that enable interoperability in LONs. (Predefined objects)</p>
TCP-IP	<p>Transmission Control Protocol/Internet Protocol</p> <p>TCP-IP is a standard protocol supported in all OS such as UNIX, an OS used in mid- to large-sized computers, Windows and Mac.</p> <p>TCP-IP was designed by an organization associated with the U.S. Department of Defense to allow for communications between computers through another route even if a part or parts of a network were destroyed.</p>

Term	Explanation
UNVT	User-defined Network Variable Types Refer to the variables used to control A/C units within LONs. They are determined according to specific projects (buildings, etc.) and, thus, are usually not used.
XIF File	Refers to a file comprised of data containing network variables for LON nodes. The company manufacturing the node (in this case, Daikin) creates the file and submits it to the NI upon receipt of an order for a system.
Architecture	Refers to the overall design concept of the computer from hardware to software. It is a systematic layout detailing the connection between the communications network and the devices in an open network.
Ethernet	Refers to the name of and standard pertaining to a LAN product developed by Xerox. Jointly developed by Xerox, DEC and Intel in 1980, Ethernet is the LAN used within BASs.
Interoperability	Refers to the coordinated interlinking between related devices. An example of this is the control of lighting, A/C, TV and the like with one R/C. If each of the respective companies involved uses a different protocol, then they have to disclose their protocols and carry out discussions on several occasions to coordinate efforts, which leads to an increase in costs. However, an open network essentially obviates such a situation and allows machines manufactured by different companies to operate together without any problems. For example, if A company's sensor breaks down, then it is possible to buy and install a product manufactured by B company that will readily operate (interconnectivity). Different devices are, thus, able to communicate and link up with each other.
Open Network	Refers to a network in which machines with different specifications are able to communicate with each other.
Object	Monitoring items and data. Refers to something that regulates the operation of the object to be controlled. The equivalent of a LON's SNVT or BACnet's object.
IEIEJ	Institute of Electrical Installation Engineers of Japan
IEIEJ Specifications	Refers to the specifications established by the institute that determines them for the Japanese version of the BACnet. (The international specifications must be certified, however, by ASRAE.) The IEIEJ Specifications feature functions added onto the BACnet according to demand in the Japanese market. Related discussions are currently being held with ASHRAE. The points of discussion are as follows: 1. Measurement: The data type used to calculate electric energy, heat and the like. This is absolutely necessary in energy management. 2. Power demand: The method of determining the contract demand with electric power companies differs with respect to the country. Accordingly, it is necessary in Japan to interpret the average electric power used over 30 minutes as the maximum electricity demand. 3. Common data dissemination methods: Due to the common adoption of comprehensive monitoring systems in Japan, it is necessary to have a system by which large volumes of disaster-related data can be efficiently transmitted. This point has not been considered in the BACnet. 4. Collective objects: Devices that support several forms of data should be managed on a per device basis. This will be proposed by the Japanese side (IEIEJ).

Term	Explanation
Closed Network	Refers to a system configured by only one manufacturer that does not allow access by other manufacturers. DIII-NET is one such example.
Gateway	Refers to a device that translates the different communication codes sent between central monitoring panels and A/C units to enable mutual communication. It is used when more than one network is connected. Interface for LONWORKS® and the Master Station are two such examples.
Commission	The work conducted when the central monitoring panel is connected to a gateway. Specifically, the data within the gateway is sent to the central monitoring panel for data confirmation. Refers to installation of settings in the node after the communication content is set via binding.
Configuration Property	Refers to parameters related to the behavior of the LON nodes. Configuration properties are set for the respective nodes by an NI when the network is being installed. They are assigned to the nodes' nonvolatile memory. Unlike network variables, configuration properties represent semi-fixed variable values.
General	Refers to the term 'general' used when conducting general or batch control. When controlling an entire system, control is not conducted on each particular A/C unit, but on a generalized basis (all of the A/C units together).
Single Vendor	Refers to a situation involving only one vendor or manufacturer.
Selecting	When a control station (central monitoring panel) sends data to a tributary station (DMS II or Interface for LONWORKS®), a message is first sent to the latter to check if the data can be received. The data is then sent upon receipt of an affirmative response from the tributary station (indicating that the data can be received).
Communication Traffic Volume	Refers to the traffic volume determined according to the number of nodes and network variables and the frequency of communication between these two.
Topology	Refers to the connection arrangement within a network. Equivalent to the wiring method in DIII-NET. Star and bus are some examples of topologies.
Neuron Chip	Refers to a LON chip. It is the interface used to access the LON.
Network Variable	The unit in which data are sent/received in communication between nodes. There are two types: network variable input (nvi) and network variable output (nvo).
Node	Refers to the devices connected by cable to the LON. In other words, it refers to the devices to be controlled by the LON or BACnet. VRV, valves and sensors are some examples.

Term	Explanation
Binding	Refers to the logical connecting between the network variables that the user wishes to communicate. It is a setting that enables communication of nvo from one device/machine and nvi from another. This is a job usually handled by an NI.
Bind	Refers to one of the activities included in a test run. Specifically, the logical address is appropriated and allocated.
Heartbeat	Refers to a function that cyclically communicates values of specific network variables. Even if a main monitoring node does not request the data (does not confirm the status of the A/C unit), the machine itself will automatically send the values. It allows the user to conclude that the node is operating normally while this value is being sent.
Free Topology	Refers to a branched free-type connection arrangement within a network. Daikin's Interface for LONWORKS® only supports free topology.
Broadcast	Refers to the simultaneous transmission of a message to all the devices connected in a system. Messages involved in the communication between devices connected within a network are simultaneously sent to all the devices within the network.
Protocol	The agreed rules and regulations used in communication between different computer programs. When the protocol differs, two computer programs are unable to comprehend each other (communicate).
Property	Refers to each of the elements comprising an object.
Profile	In terms of a LON, the following are examples of items that are determined for each function of the respective nodes in the LON: - Network variable type - Meaning of the network variable (function) - Range and meaning of the network variable value (function). Standardizing these ensures interconnectivity. However, a LON is not configured for VRVs or PAs, so profiles for such A/C systems must be created by each manufacturer in accordance with the respective network variable regulations. (Due to the fact that the profiles differ with respect to the manufacturer, profiles such as those for VRVs and PAs are not certified by LONMARK. However, because they conform with regulations, they can be treated as open networks by disclosing the network variables.
Vendor	The seller or manufacturer
Polling	When the control station does not have the necessary data (the central monitoring panel does not have any commands), it sends requests at regular intervals to each tributary station asking whether it has any data transmission requests (data that the tributary station would like to communicate to the control station). The control station sequentially gives each of the tributary stations request transmission rights, allowing them to send the respective data.
Multi-vendor	Refers to various machine/device manufacturers. The term 'multi-vendor environment' is also often used.
Unicast	Refers to the sending of messages only to specified devices. Specifically, it is the sending of messages between devices connected in a network on a one-to-one basis.
Router	Refers to a device used for connections between different networks. A router forwards data packets between networks. In an internal (in-company) LAN, it is used to connect the LANs installed on a per floor basis. Meanwhile, a dial-up router is used to connect the Internet with a LAN. Routers are also used for connections between an Ethernet and LON, for example, in the field of open protocols used for building control.

Part 5

LON (Interface

for use in LONWORKS®)

Q&A

1. LON (Interface for use in LONWORKS®) Q&A.....56

1. LON (Interface for use in LONWORKS®) Q&A

No.	Q	A
1	Is the number of indoor units that can be connected to one Interface for LONWORKS® 64?	A maximum of 64 groups can be connected to it.
2	When a group is being operated via a remote controller, does the sub machine require an address as in the case of fee management?	No, an address is not necessary for sub machines.
3	What centralized devices can be built onto the system?	Ve-up Controller Centralized Management Controller ON/OFF Controller Heat Storage Controller
4	How are T1 and T2 connected?	With microcurrents (minute electric currents).
5	Are surge killers and noise filters necessary for the power supply?	No, they are not because they are already on board.
6	What does the term 'Sub Group Address Control...' in the specifications mean?	It refers to centralized devices other than the Interface for LONWORKS®. In other words, it pertains to 'secondary centralized devices'.
7	Is the '30-second data collection cycle' predetermined?	This cycle is the manner in which Daikin addresses the issue in cases of absence of an NI (network integrator). However, if an NI is present, network design will be requested of the NI regardless of the cycle. We have never observed an NI in any of the projects we have handled to date. There have been system designers (central monitoring panel manufacturers), but no NIs.
8	Is the maximum number of points that the Interface for LONWORKS® can control 600?	The number of points that the Interface for LONWORKS® can control has been calculated as follows: Acknowledged Service: 20 points/second Data Collection Cycle: 30 seconds Number of control points = 20 x 30 = 600 Consider the Acknowledged Service to be the processing capability of the Interface for LONWORKS®. If an NI is present, the NI would determine the data collection cycle, so it is not limited to 30 seconds. In cases when an NI is not present, the number of items is assumed as 600 based upon a 30-second cycle.
9	What is the LonMaker?	It is an Echelon-designed software that enables binding and the like.
10	What can the Interface for LONWORKS® control for other models including RA?	Please refer to the list of functions by model.

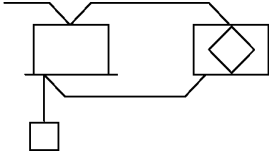
11	Addresses are required for sub machines within R/C groups when a fee management unit is used together with the Interface for LONWORKS®. In such cases, are the sub machines included within the total of 600 control points?	It is necessary to limit the number of A/C groups to 64 or less. However, if the main central monitoring panel does not control nor monitor (no binding), the sub machines can be excluded when calculating communications traffic volume (600 = control points X number of groups).
12	<p>The following displays control with a LON via an R/C-aided interlocked control system between an indoor unit and a HRV.</p>  <p>Between indoor units and the HRV: Controllable items between the LON and the HRV when the system is operated via an R/C are as follows:</p> <p>From the LON to the HRV</p> <p>From the HRV to the LON</p>	<p>Independent operation: No Airflow rate changeover: No Operation mode changeover: No Filter reset: Yes Start/Stop: Start/Stop operation and status report on an interlocking basis. Error message transmission: Yes Error code transmission: Yes (Unit numbers are not transmitted.) Filter sign transmission: Yes Other transmissions: Only Start/Stop/Error messages: Yes (Operation mode and airflow rate: No)</p>
13	What about the issue of the Node Object, General Object and Independent Object?	Thinking is centered about the Interface for LONWORKS®. Observation reveals that the central monitoring panel is connected to the Interface for LONWORKS®. This represents the Node Object. 64 groups of indoor units are also connected and altogether referred to as the General Object. Each of the 64 groups is referred to as Independent Objects. Therefore, the Interface for LONWORKS® has 66 objects. Subtracting the Node and General objects leaves us with the 64 objects as represented by the 64 groups.
14	How does a System Forced Off work?	Either the LON monitoring node (central monitoring panel) issues an 'nviSystemoff' message to the General Node or the Interface for LONWORKS®s 'T1/T2' is manually input. Either option may be chosen.

15	Can heat storage operation be controlled by the LON?	No, it cannot. The LON is bound to the indoor unit groups. Heat storage is a command sent to outdoor units, so this is not possible with the LON.																						
16	When a centralized controller is used along with the LON, can the 'Operation code' of the centralized controller be used?	When a Interface for LONWORKS® is being used, the 'Operation code' of a centralized controller cannot be used.																						
17	What is the relationship between the DIII-NET addresses and the LON A/C numbers?	If a location address setting is lacking, it is also necessary to leave the LON A/C number out. <table border="1"> <thead> <tr> <th>DIII-NET</th> <th>LON</th> </tr> </thead> <tbody> <tr> <td>1-00</td> <td>1</td> </tr> <tr> <td>1-01</td> <td>2</td> </tr> <tr> <td>1-02</td> <td>3</td> </tr> <tr> <td>1-03</td> <td>4</td> </tr> <tr> <td>1-04</td> <td>5</td> </tr> <tr> <td>1-05</td> <td>6</td> </tr> <tr> <td>2-00</td> <td>17 <--</td> </tr> <tr> <td>2-01</td> <td>18</td> </tr> <tr> <td>2-02</td> <td>19</td> </tr> <tr> <td>2-02</td> <td>20</td> </tr> </tbody> </table>	DIII-NET	LON	1-00	1	1-01	2	1-02	3	1-03	4	1-04	5	1-05	6	2-00	17 <--	2-01	18	2-02	19	2-02	20
DIII-NET	LON																							
1-00	1																							
1-01	2																							
1-02	3																							
1-03	4																							
1-04	5																							
1-05	6																							
2-00	17 <--																							
2-01	18																							
2-02	19																							
2-02	20																							
18	If the 'Auto' command is transmitted to an A/C unit that has no Auto mode, what mode does the indoor unit actually go into?	The indoor unit ignores the command. It maintains the actual temperature control mode.																						
19	What is displayed on the LON when the airflow rate on the Sky Air is set at 'Medium'?	The LON displays airflow rates of either 'High' or 'Low'. If the value on the DIII-NET is 4 or less, then the display is 'Low'. Anything 5 or more results in a display of 'High'. The 'Medium' setting on the R/C is equivalent to a 3, so the display on the LON would be 'Low'.																						
20	What is displayed on the LON when the R/C is set to 'Auto'?	It displays the actual operation mode. (Cooling/Heating/Fan)																						
21	What occurs when a 'Remote Control Rejection (On/Off Operation, Operation Mode Setting, Temperature Setting)' message is bound to machines without R/Cs?	The bind would be meaningless. If the LON Monitoring Node (central monitoring panel) attempts to display the status value, 'Setting Prohibited' would be read.																						
22	Does an error occur when particular functions not supported in machines are bound to the machines? For example, does an error occur when an airflow rate setting variable is bound to a machine that does not support an airflow rate setting?	No, an error does not occur. Even if an input network variable (input NV) corresponding to a function not supported in an indoor unit is bound, an error will not occur upon binding. Interface for LONWORKS® NVs exist regardless of the type of indoor unit(s) connected, so errors do not occur when binding.																						
23	When an error does not occur in such cases (as mentioned above), does some type of error occur when actual instructions are issued?	No, an error does not occur.																						
24	What about commands concerning functions not supported by indoor units?	Input/output NVs corresponding to functions that are not supported by indoor units are not bound. Values assigned to input/output NVs corresponding to functions that are not supported by indoor units are ignored. Values of output NVs corresponding to functions that are not supported by indoor units are not guaranteed.																						

25	What is 'Error Status Report'?	When an indoor unit malfunctions, it is merely reported as an error.
26	What is 'Error Code Report'?	When an indoor unit malfunctions, the respective 'Error Code' is reported.
27	Do both 'Error Status Report' and 'Error Code Report' have to be bound?	Not necessarily. Only 'Error Status Report' or only 'Error Code Report' can be bound.
28	Are 'Filter Sign' and 'A/C Communications Status' included in the 'Error Status Report'?	A/C Communications Status' is. The error code is 'UE'. 'Filter Sign' is not included.
29	Why is 'A/C Communications Status' bound?	Based on abnormalities in the 'A/C Communications Status', a breakdown in communications between the A/C units and the LON due to a power failure can be immediately detected.
30	Are there any error codes that are not included in the 'Error Status Report' or 'Error Code Report'?	An error code for the 'Alarm' level is not reported to the central monitoring panel. (Example: A7 (Vane motor error) = Swing flap has ceased to function properly, yet this does not adversely affect cooling operation.)
31	What is the display on the LON when a malfunction occurs?	The LON displays either 'Operation' or 'Error'.
32	The latest command/setting issued by either the central monitoring panel or R/C that takes priority include: 1. On/Off Command 2. Operation Mode Setting 3. Temperature Setting, and 4. Airflow Rate Setting. However, when the NVI cycle transmission (including the above items) is conducted from the central monitoring panel, the following problem could occur. Have countermeasures been taken? Example: After the temperature has been set at 26°C with the central monitoring panel, it is changed to 24°C with the R/C. When the cycle transmission from the central monitoring panel is (subsequently) conducted at 26°C, the subsequent setting of 26°C takes precedence. This effectively invalidates any R/C operation.	Yes, it could occur so we advise you not to conduct cycle transmission with regard to NVIs.
33	What procedure should be taken to conduct a test run?	Conduct a test run of the local system (DIII-NET) beforehand. Use a PC to conduct a LON test run, turning the system On and Off from the PC.

34	A malfunction was intentionally created during the test run in order to check the working order of 'Error Status Report'. However, the report was not transmitted. Does this indicate a problem with the Interface for LONWORKS®?	There are error codes that are not immediately reported to the LON (mask codes). From U3 to U9 and UJ (communications errors) allow the system to automatically restore itself to proper working order and, hence, do not transmit any messages of the like. It is reported, however, if the abnormality continues for 5 minutes. (The abnormality is displayed on the DIII-NET, which includes the R/C and centralized devices, but the report to the LON is delayed for 5 minutes.)
35	What happens when the receipt of the NVs of the Interface for LONWORKS® are cut off because the central monitoring panel has shut down?	Central monitoring panel shutdowns do not affect the Interface for LONWORKS®. Such a shutdown would only make operation from a central monitoring panel impossible.
36	What happens if electricity is running to the Interface for LONWORKS®, but the indoor units are not receiving power?	This would result in an A/C communications error.
37	What happens if electricity is running to the Interface for LONWORKS®, but the outdoor units are not receiving power?	This would result in an indoor/outdoor unit transmission error.
38	How long does the backup last when electricity to the Interface for LONWORKS® is cut?	With a charge of 24 hours, it can last approximately one month. Be sure to put 'SW1' to ON during the test run.
39	After power is restored, is there anything to be done to the Interface for LONWORKS®?	No, nothing is required.
40	What precautions must be taken when power is restored after a failure?	<p>1. Handling when power is restored after a failure</p> <p>After power has been restored to the outdoor and indoor units, a certain amount of time is required for initialization of transmission to outdoor and indoor units. Therefore, it is recommended that the restoration command be issued at least 5 minutes after electrical service has been restored to both the outdoor and indoor units. 'Start Command' issued during initialization will be ignored.</p> <p>There is no message sent once electrical service has been restored to A/C units.</p> <p>2. Operation when electrical service has been restored</p> <p>The input NV (network variables sent from the central monitoring panel to the A/C units) in the Interface for LONWORKS® return to the default values (=0) after restoration. The command value that has been transmitted to the A/C units before the electricity is cut is collected by the A/C units after restoration of service and reflected in the output NVs (network variables sent from A/C units to central monitoring panel).</p> <p>In terms of input NVs, the final command value sent from the main monitoring node on the LON is maintained when the Interface for LONWORKS® is in normal operation. However, once power is cut, the default value is used until the next command value is transmitted after power is restored.</p> <p>If the command value that was issued immediately prior to the power failure has already been transmitted to the A/C units before the electricity was cut, then the value is collected from the A/C units after power is restored and reflected in the output NV (not the input NV).</p> <p>Therefore, the R/C display and the input NV value will not correspond immediately after power is restored.</p> <p>This not only occurs after restoration of electrical service, but also when the R/C is used.</p> <p>The output NV data is collected from the A/C units after restoration of electrical service and the status value is displayed in the output NV. Bound output NV data is notified as a status change.</p> <p>*With regard to a 'System Forced OFF' command, the normal status is returned after restoration of electrical service even if a 'System Forced OFF status' exists before the power failure (the status prior to the power failure is not maintained).</p>

40		<p>3. Items of note</p> <p>Attention should be heeded towards the following control commands: 'Forced Thermostat OFF Setting' 'Remote ON/OFF Control Rejection' 'Remote Operation Mode Control Rejection' 'Remote Temperature Setting Control Rejection' 'System Forced OFF Setting'</p> <p>When the following commands have been sent to the A/C units through the Interface for LONWORKS® at the time of power failure:</p> <p>'Forced Thermostat OFF Setting' 'Remote ON/OFF Control Rejection' 'Remote Operation Mode Control Rejection' 'Remote Temperature Setting Control Rejection' OR when the A/C units are set at the following through the Interface for LONWORKS® at the time of power failure: 'System Forced OFF Setting'</p> <p>(A) In the event a centralized controller is being used in addition to the Interface for LONWORKS® and the electricity continues to run through the device, the A/C units continue to be controlled via the following commands during the power failure and after power/electricity being restored:</p> <p>'Forced Thermostat OFF Setting' 'Remote ON/OFF Control Rejection' 'Remote Operation Mode Control Rejection' 'Remote Temperature Setting Control Rejection'</p> <p>Meanwhile, 'System Forced OFF Setting' is being reset.</p> <p>(B) In the event a centralized controller is not being used in addition to the Interface for LONWORKS® or electricity to the centralized controller is also cut, all of the following commands are reset while the electrical service is down:</p> <p>'Forced Thermostat OFF Setting' 'Remote ON/OFF Control Rejection' 'Remote Operation Mode Control Rejection' 'Remote Temperature Setting Control Rejection' 'System Forced OFF Setting'</p> <p>After the electrical service has been restored, only the following commands are set:</p> <p>'Remote ON/OFF Control Rejection' 'Remote Operation Mode Control Rejection' 'Remote Temperature Setting Control Rejection'</p>
----	--	--

Part 6 Daikin's LON Binding Agreement

1. Daikin's LON Binding Agreement.....64

1. Daikin's LON Binding Agreement

1. **JMT** - (Joint Matching Test) This is necessary for every independent BMS maker. In the case that the BMS has updated their system by either software or hardware changes after a JMT has been carried out a following JMT will be required.
2. **Binding** - BMS maker to carry out binding. This is NOT to be done by Daikin since it is directly related to the BMS side. All LON royalties need to be paid to Echelon by BMS maker for each LON engineered. Binding is the virtual engineering between the BMS and the BMS LON interface.
3. **Interface for LONWORKS® D-BACS setup-tool** - Use of Daikin's Interface for LONWORKS® D-BACS setup-tool for confirming the operation/state of connected A/C units prior to connection with the BMS system.
4. **Commission** - First step, only using Interface for LONWORKS®, without connecting BMS. This is to be carried out by Daikin engineering staff with the use of the LonMaker tool. The equipment will be provided by DIL for the duration of testing. Second Step (Binding) is connecting with the BMS. This is to be carried out by BMS maker or NI (Network Integrator). This binding is done with the LonMaker tool.

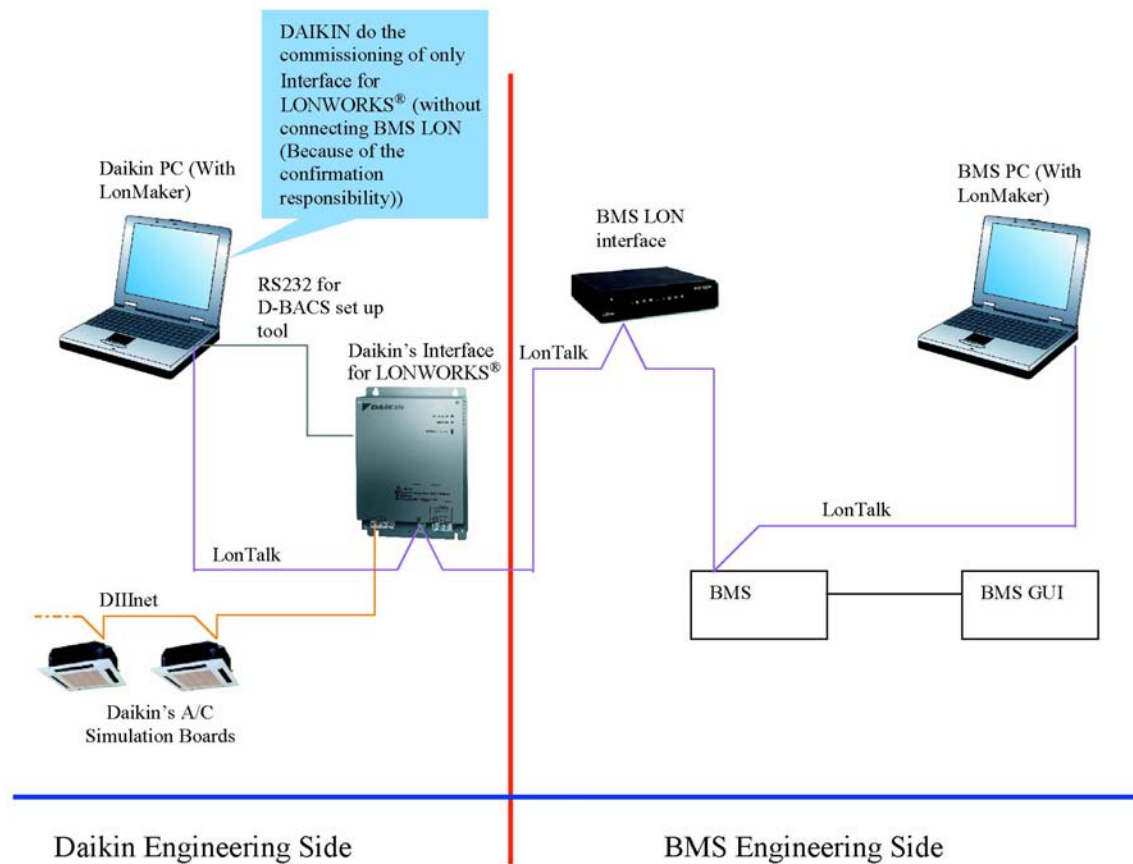

Part 7

Interface for use in LONWORKS[®]

Commissioning Manual

MODEL:DMS504B51

1. Foreword	66
2. Procedure for Commissioning	67
3. Setting the Service PC	68
3.1 Communication Specification	68
3.2 RS232C Cable Connecting Diagram.....	68
3.3 Hyperterminal (VT Terminal Emulation) Setting.....	69
4. Connection to Service PC and Start	71
4.1 Wiring	71
4.2 Starting Hyperterminal.....	71
5. Operation Check	72
5.1 Check the Status of DIII Network	73
5.2 Indoor Unit Operation	73
6. Binding Work.....	74
7. LED Indication.....	75
8. Terminal Resistance	76
8.1 How to Set Terminal Resistance	76
9. Appendix 1 Service PC Command Function.....	77
10. Check List	79
11. Troubleshooting	80
12. Others	81
12.1 Backup Battery Switch for The Interface for LONWORKS [®]	81
12.2 Power Supply Voltage of The Interface for LONWORKS [®]	81

1. Foreword

Before using Interface for LONWORKS®, it is necessary to commission before starting normal operations.

■ Preparation of test

[What to be prepared]

- (1) PC: 1 unit
- (2) RS232C Cross cable: 1 (same as the one used for i-Touch controller)
- (3) VT terminal emulation software (Hyperterminal, Tera Term, etc.): One set

2. Procedure for Commissioning

The procedure for commissioning Interface for LONWORKS® is shown below:

**Make sure that the battery switch is turned ON (see the figure in P.76).
If it is OFF, turn it ON. (see the installation manual)**

The work to be carried out by the service department

Set the service PC

Connect the service PC and start

Confirm the operation

The work to be carried out by Network Integrator (NI)

Note: This is not a work to be carried out by
the service department.

Binding work

3. Setting the Service PC

3.1 Communication Specification

Communication interface	RS232C
Transmission speed	9600bps
Synchronization system	Start-Stop synchronization
Communication control procedure	
Transmission code	8 bit + Non-parity + 1 Stop-bit
Connector	D-SUB 9 pin Female -Female

3.2 RS232C Cable Connecting Diagram

Use the cables shown below:

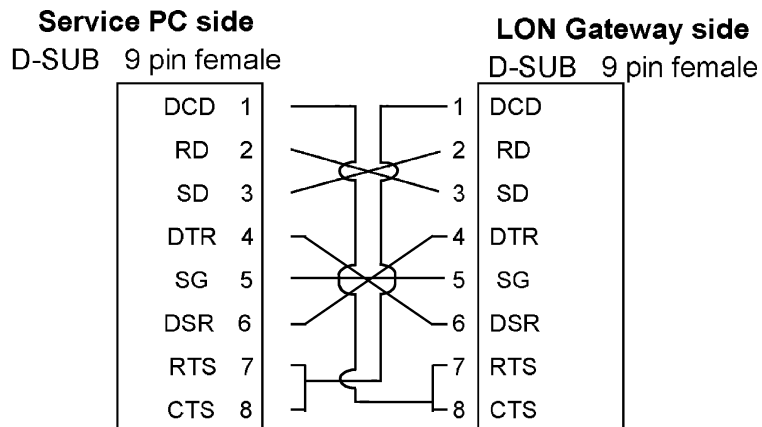

[For reference]

To be used for commissioning of i-Touch Controller
The cable RS232C is usable.

(Example of usable communication cable)

Sanwa Supply Ltd.
Cable RS232C
KRS-403XF-07K
Cross cable 0.75 mm,

3.3 Hyperterminal (VT Terminal Emulation) Setting

(1) Select [Start]–[Program]–[Accessory]–[Communication]–[Hyperterminal].

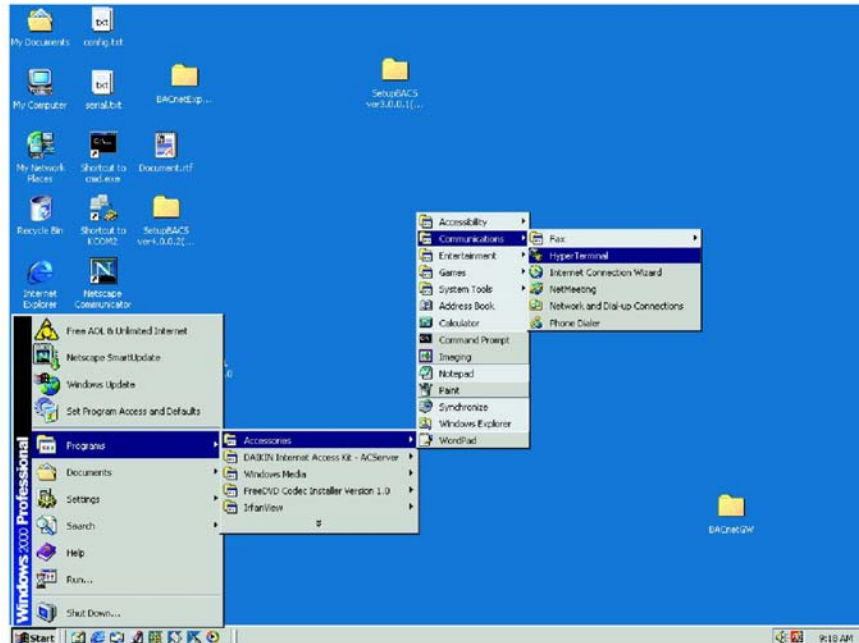

(2) The following displays.





(3) Enter Interface for LONWORKS®.



(4) Set the connection method to "Direct to Com1" and press the key OK.

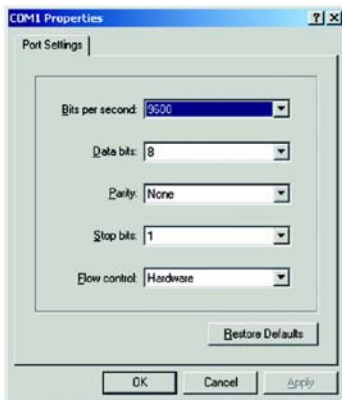

(5) Set the port as shown left and press the key OK

bit/sec : 9600
 data bit : 8
 parity : none
 stop bit : 1
 flow control : hardware



(6) When the HyperTerminal ends, select "Yes"

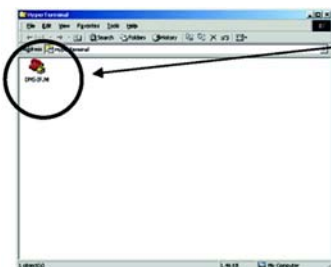

(7) Double-click the icon [Interface for LONWORKS®]

The next start is OK by just double-clicking the icon [Interface for LONWORKS®].

4. Connection to Service PC and Start

4.1 Wiring

Connect as shown below.

[Caution]

1. Make sure to cut off the power supply to the equipment before opening the upper cover.
2. Make sure to connect the service PC before turning on the power supply to the equipment.
3. Do not touch the control PCB except for the connectors, since the PCB might be damaged by static electricity.
4. To avoid electric shock, do not touch the high voltage side.

Interface for LONWORKS® (CN7)

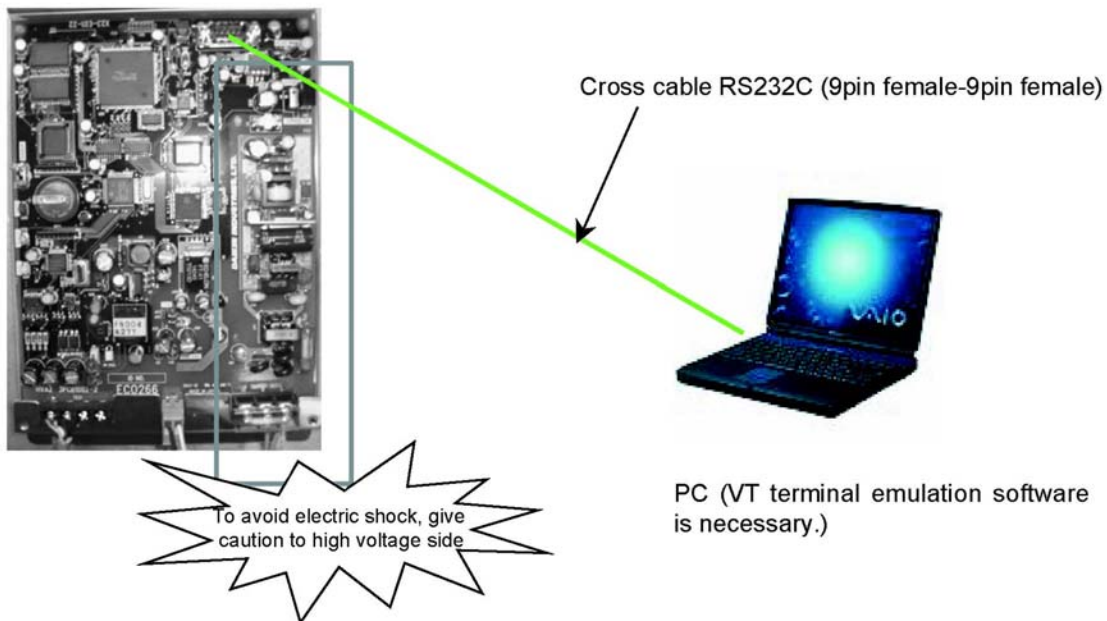

4.2 Starting Hyperterminal

(1) Select [Start]–[Program]–[Accessory]–[Communication]–Hyperterminal].

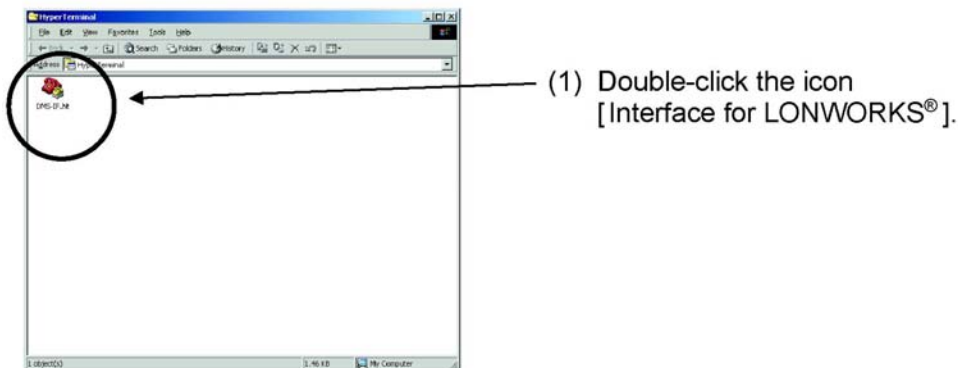

5. Operation Check

Carry out ON/OFF operation of each connected indoor unit and check if each indoor unit operates or stops as instructed. If it does, the unit is normal.

[Check point]

1. Check if ON/OFF of all the connected indoor units can be operated from Interface for LONWORKS[®] or not.
By carrying out this check, it is possible to check if the centralized addresses of the indoor units are correctly set or not.

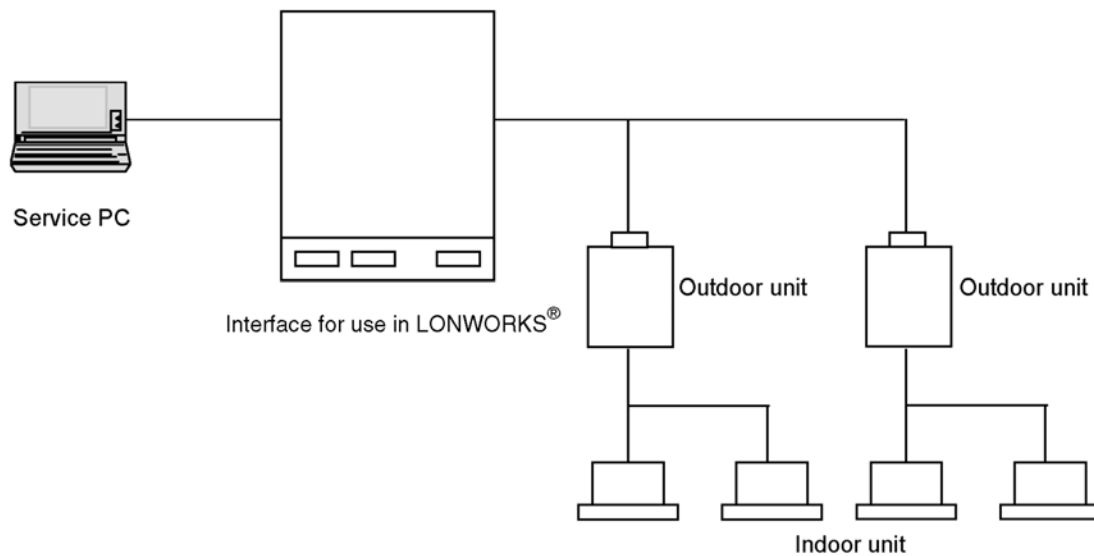

Caution: If the ON/OFF operation of the air conditioner is carried out by the service PC and if this air conditioner is to be monitored by the service PC, the monitoring must be initiated one minute or more after the ON/OFF operation. It is because the Interface for LONWORKS[®] retains the instructed value for one minute after the ON/OFF operation and then responds. After one minute elapses, it responds to the actual operating conditions collected through the DIII network.

5.1 Check the Status of DIII Network

After the hyperterminal rises, press any key.
If the key is pressed, prompt **LONGW>** appears.
(If the key H is pressed, it indicates command help.)

```

LONGW> Press C DIII-NET check
LONGW> (C)heck D3-NET Interface

OK : D3 Master/Slave setting
OK : D3 Address setting
OK : D3 Pole detection (photo coupler)

Indication when master duplication error occurs
Error MA : Duplicate D3 master
Correct the Master/Slave connector and
Restart LON Gateway

Indication when D3 address duplication occurs
Error MC : Duplicate D3 address
Correct the address and
Restart LON Gateway

Indication when D3 polar decision error occurs
(photo coupler error)
Error M1 : D3 Pole Error
Check the photo coupler

LONGW>
    
```

- (1) Enter C
- (2) Confirm that the results are all OK

Note) In case of NG, see the left

5.2 Indoor Unit Operation

```

LONGW> Press S AC ON/OFF command
LONGW> (S)et AC : ON or OFF
Which AC do you wish to set? [1-64] Enter 13(+Enter)
Enter 1 (ON) or 0 (OFF) for AC13. Enter 1 (+Enter)
Set 1 AC13 ON Complete (No.1 unit operation command)
    
```

- (1) Enter S
- (2) Enter the indoor unit No. you wish to ON/OFF
- (3) Enter "1" for ON
Enter "0" for OFF
- (4) Confirm that the designated unit operates ON and OFF as indicated.
- (5) Carry out the above work to all the connected units.

[Caution]
The relation between the indoor unit No. to be entered and the centralized address is as follows:

Indoor unit No.	Centralized address
1	1-00
...	...
16	1-15
17	2-00
...	...
32	2-15

Indoor unit No.	Centralized address
33	3-00
...	...
48	3-15
49	4-00
...	...
64	4-15

6. Binding Work

This work is to be carried out by NI and not by the service department.

[Outline]

The binding work is a work to set what kind of equipment is connected to LONWORKS network.

7. LED Indication

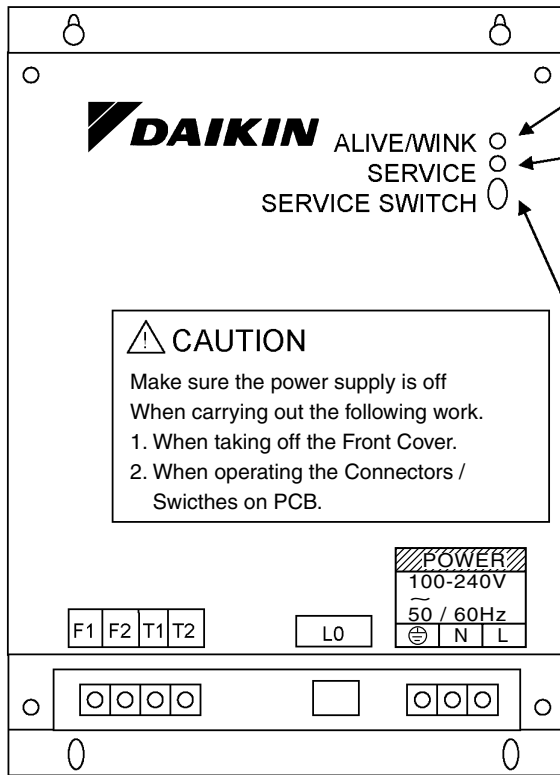

ALIVE/WINK LED
 MICROCOMPUTER NORMAL LED
 When in normal operation, it flashes in 0.4 sec cycles

SERVICE LED

LED Details

- OFF During normal operation
- Flashes The bind data set by NI has disappeared due to some reason.
 Note) NI needs to redo the bind work.
- OFF While the service switch is being pushed, it flashes. (if let go, LED turns OFF. Even if the switch is not being pushed, if LED turns ON, the body is malfunctioning.
 Note) Replace the body.

When NI carries out the binding work, this switch must be pushed.

8. Terminal Resistance

This setting is to be carried out only when it is requested by NI.
 When no request is made, it is not required to carry out the setting.

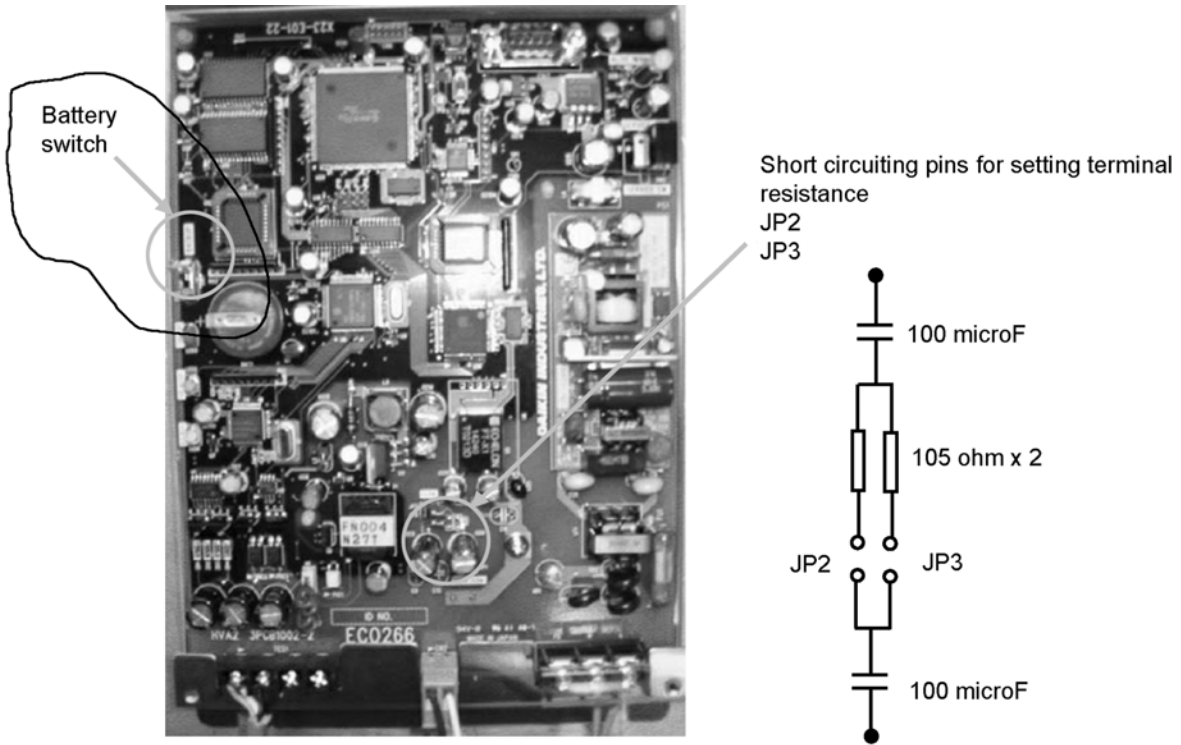

— Terminal resistance circuit —

8.1 How to Set Terminal Resistance

The status of short circuiting socket without terminal resistance (the status when shipped out of the factory)

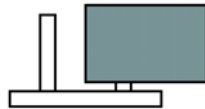

The status of short circuiting socket with terminal resistance



Note) If the terminal resistance is 105 ohms,
 set the short circuiting socket only to JP2 as shown left.

Note) If the terminal resistance is 52.5 ohms,
 set the short circuiting socket to both JP2 and JP3 as shown left.

9. Appendix 1 Service PC Command Function

- (1) Check the DIII NET status: C command
Indicate the 3 kinds of status values related to DIII NET which are detected when the power supply is turned ON or when restarted.
 - * DIII master duplication error
 - * DIII address duplication (existence of equipment having centralized address 0x04 as same as Interface for LONWORKS®)
 - * DIII polar decision error (photo coupler error)
- (2) AC ON-OFF command : S command
After designating the AC No. [1-64], issue ON or OFF command.
- (3) Monitor the ON-OFF status of AC : G command
After designating the AC No. [1-64], indicate the current ON-OFF status.
- (4) Interface for LONWORKS® restart command : R command
Restart Interface for LONWORKS®.
- (5) Indication of Neuron ID : N command
Indicate the ID of mounted Neuron Chip.
- (6) Indication of Version No. : V command
Indicate the software version No.
- (7) Indication of Log : L command
Indicate the Log of past 31 cases which software recorded.
- (8) Indication of Help : H command
Indicate the command list.

☆ Examples of operation

```

LONGW> (H)elp with commands Press H Command list
H -- (H)elp with commands.
C -- (C)heck D3-NET Interface.
S -- (S)et AC : ON or OFF.
G -- (G)et AC Status : ON or OFF.
R -- (R)estart LON Gateway.
N -- Print (N)euron ID.
V -- Print (V)ersion Number.
L -- Print (L)ogs.
LONGW> (C)heck D3-NET Interface Press C Check the D3 NET status
OK : D3 Master/Slave setting.
OK : D3 address setting.
OK : D3 Pole detection (photo coupler).

Indication of Master duplication error
Error MA : Duplicate D3 master.
Correct the Master/Slave connector
and Restart LON Gateway.

Indication of D3 address duplication error
Error MC : Duplicate D3 address.
Correct the address
and Restart LON Gateway.

Indication of D3 polar decision error (photo coupler error)
Error M1 : D3 Pole Error.
Check the photo coupler.

LONGW>

```

☆Operation example (continued)

```

LONGW> (R)estart LON Gateway Press R Restart Interface for LONWORKS®
Are you sure to restart LON Gateway? Hit Y or [N]:Y Press Y
Again, Restart LON Gateway, OK? Hit Y or [N]: Press Y again
Interface for LONWORKS® restarts at this point

Indication of cancellation while processing
LONGW> (R)estart LON Gateway
Are you sure to restart LON Gateway? Hit Y or [N]:N
Not restart LON Gateway.
LONGW> (R)estart LON Gateway
Are you sure to restart LON Gateway? Hit Y or [N]:Y
Again, Restart LON Gateway, OK? Hit Y or [N]:N
Not restart LON Gateway.
LONGW>

LONGW> (S)et AC : ON or OFF Press S AC ON-OFF command
Which AC do you wish to set? [1-64] Enter :13 (+Enter)
Enter 1(ON) or 0(OFF) for AC:13 Enter :1 (+Enter)
set AC13 ON Complete (No.13 Operation command)
LONGW> (G)et AC Status : ON or OFF Press G Monitoring of AC status
Which AC do you wish to see? [1-64] Enter :13 (+Enter)
AC 13 is ON state
LONGW> Print (N)euron ID Press N Indication of NeuronID
NID is 0:a2:3:36:1:0
LONGW> Print (V)ersion Number Press V Indication of version
Ver.is 1.00
LONGW> Print (L)ogs Press L Indication of Log
0Day 00:00:00 from Start: Info : LON Gateway Started OK
0Day 00:08:03 from Start: Info : Restarted by Service Man
⋮ (Indication of 31 cases)
NO DATA
Running time is 98Day 12:34:21 from Start (Elapsed time from the latest restart)
LONGW>
    
```

☆The list of recorded sentences in LOG

Information	
"Info : LON Gateway Started OK"	Start LON Gateway
"Info : Restarted by Service Man"	Interface for LONWORKS® is restarted by serviceman PC
"Info : Found MIP reset"	NeuronChip is initiated from LON network
"Info : miRESET Sent OK"	Initiated NeuronChip
"Info : miFLUSH_CANCEL Sent OK"	Started NeuronChip
"Info : Reopened network driver"	Reopened LON i/f
Error information	
"Error MA : Duplicate D3 master."	D3 Master duplication error
"Error MC : Duplicate D3 address."	D3 Address duplication (0x04) error
"Error M1 : D3 Pole Error."	D3 Pole judgement error (photo coupler error)
"Error : D3 Send Timeout."	D3 Transmission of time out error
"Error : D3 Send buffer Full."	D3 Transmission of buffer full error
"Error : H8Comm: Packet length Error"	D3 There is an error in receiving packet size
"Error : NvCP on BBRAM. Checksum Error"	There was an error in configuration parameter on nonvolatile memory
"Error : NvConfig on BBRAM. Checksum Error"	There was an error in bind information on nonvolatile memory
"Error : LDBUF Overflow"	Lon->D3 notification overflowed from buffer
"Error : Could not reopen network driver"	Could not reopen LON i/f

10. Check List

Test No.	Items	Indication of results	Decision	Criteria
	<ul style="list-style-type: none"> • Check the DIII NET status <ul style="list-style-type: none"> • Issue C command. No error in indication is acceptable • Confirm AC ON-OFF <ul style="list-style-type: none"> • Issue AC operation command (S command) and operate the corresponding indoor unit <p>Note) To be carried out by each connected indoor unit.</p>			<p>All indication shall be OK</p> <p>Confirm with all the indoor units</p>

11. Troubleshooting

No.	Items	Check point	Measures
1	SERVICE LED flashes	Is the backup battery effective switch turned ON?	Information on settings related to LONWORKS network has disappeared. After setting the switch to effective, request NI to redo the binding work.
2	SERVICE LED lights up	—	It is a failure of hardware. Replace the body.
3	While checking the DIII NET status, the following error was indicated. Error MA : Duplicate DIII master. Error MC : Duplicate DIII address. Error M1 : DIII Pole Error.	Master duplication error It occurs when used together with the other centralized equipment. There are multiple units of centralized equipment with connectors for setting centralized masters. DIII address duplication error Are multiple Interface for LONWORKS® mounted on DIII NET? Is Masterstation2 mounted on DIII NET? DIII Pole decision error	As for the equipment with connectors for setting the centralized master, the number allowed to exist on the DIII NET is no more than one. Remove all the connectors except for Interface for LONWORKS® for setting the centralized masters from the centralized equipment (It is necessary to reset the power supply of all the centralized equipment) Note) If the centralized equipment with a function to calculate the power rates (such as iController) is used together, set this equipment to become the centralized master. The equipment shown left cannot be used together. Confirm which equipment can be used together for centralization. It is an error of control PCB. Replace the body.

12. Others

12.1 Backup Battery Switch for The Interface for LONWORKS®

[Important Matters]

Never fail to turn on the backup battery switch after the Interface for LONWORKS® is completely installed.

[Reason]

After the Interface for LONWORKS® is installed, the NI (Network Integrator) will execute binding for connecting with the central monitoring panel. This is a configuration operation for matching the control monitoring items between the central monitoring panel and the Interface for LONWORKS®. These data are saved in the Interface for LONWORKS®. However, if the backup battery switch is OFF, they will disappear.

If they are not saved, the NI will need to execute the binding operation again, which will increase the cost. So, be sure to turn on the backup battery switch.

[Remarks]

Although this operation (turning on the backup battery switch) is specified as necessary in the installation manual, it must be emphasized since several customers did not execute it, which led to serious problems.

12.2 Power Supply Voltage of The Interface for LONWORKS®

[Important Matter]

If the operation fails (trial operation of the Interface for LONWORKS® is not available, etc.), confirm the power supply voltage first.

[Reason]

Even if the power supply voltage for the Interface for LONWORKS® is lower than the rated value, the LED on the panel (ALIVE/WINK) may flash. Therefore, when the operation is not normal (air conditioner cannot start or stop during trial operation, etc.), measure the power supply voltage to confirm that it is within the rated value.

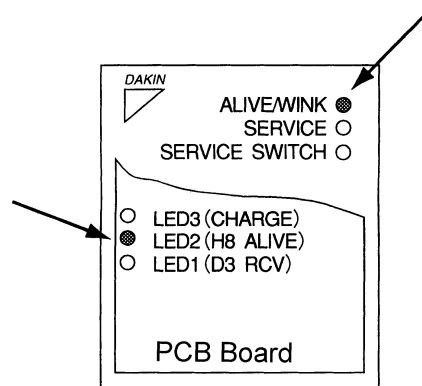

[Remarks]

Rated power supply voltage: AC 100 V ~ 240 V +10%, -15%

The LED will display the status as shown below if the power supply voltage exceeds the rated value.

Power Supply	LED on panel (ALIVE/WINK)	LED on PCB Board inside of panel (H8 ALIVE)
0 ≤ Power Supply ≤ 10 V	Off	Off
10 ≤ Power Supply ≤ 30 V	Flash (orange)	Off
30 ≤ Power Supply < 85 V	Flash (orange)	Flash

Notice:

When the power supply is lower than the rated value, it does not function normally even though the LED flashes. ALIVE/WINK LED is yellow or red during normal performance, but changes to orange if the power supply is lower than the rated value (ALIVE/WINK LED may flash red when commissioning).

Part 8 Installation Manual (DMS504B51)

1. Installation Manual	84
1.1 DMS504B51	84

1. Installation Manual

1.1 DMS504B51

Please carefully read the "Safety Precautions" as follows and install the controller as instructed.

- The precautions given herein are classified as " ! WARNING" and " ! CAUTION". However, particular precautions which, unless they are observed in installing that could result in death and serious injury are identified by " ! WARNING". Needless to say even other precautions which are not identified by " ! CAUTION" could lead to a serious accident unless they are observed. Therefore, please do not fail to observe these precautions.
- After completion of the installation, please conduct a test run on the controller to check that it is free from any fault and in addition simultaneously instruct the user how to operate and maintain it correctly (in accordance with the Operation Manual).
Furthermore, request the user to keep this manual together with the Operation Manual for future reference.

WARNING

The installation work must be requested by the dealer.
Installation by user himself could cause electric shock, fire, etc.

Install correctly in accordance with this installation manual.
Incorrect installation, if any, may cause electric shock, fire, etc.

Installing; do not fail to use the accessories and specific parts which are supplied together with the indoor unit.
Failure to observe this instruction may cause electric shock, fire, etc.

Perform correctly the electric wiring connection using the specified cables and firmly clamp each terminal connector to prevent cable load from being transferred thereto.
Unstable and improper cable connecting and clamping could cause overheating, fire, etc.

CAUTION

Grounding.
Do not connect the grounding wire to any of gas pipes, city water pipes, lightning rods, or telephone grounding wire. Imperfect grounding would cause electric shock.



Avoid installing at the following locations.

1. Cuisine and other place where the controller is inevitably exposed to mineral oil, scattered oil or steam.
Installing at such places could cause deterioration of the resin parts, corrosion or short circuit.
2. Where corrosive gases such as sulfur dioxide generate inevitably.
3. Where a machine as generates electromagnetic waves. Installing at such a place could cause trouble of the control line and failure of normal air-conditioning operation.
4. Where leak of combustible gas is forecast and place where volatile ignitable gases such as thinner, gasoline, etc. are handled.

Should such gas leak and accumulate around the devices, could cause igniting.

SETTING THE BACKUP BATTERY SWITCH.

1 Components

The following parts are attached to this unit. Make sure to check them before installation.

Interface for LONWORKS®
DMS504B51

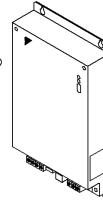

INSTALLATION
MANUAL

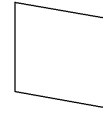

2 Names and functions of each part

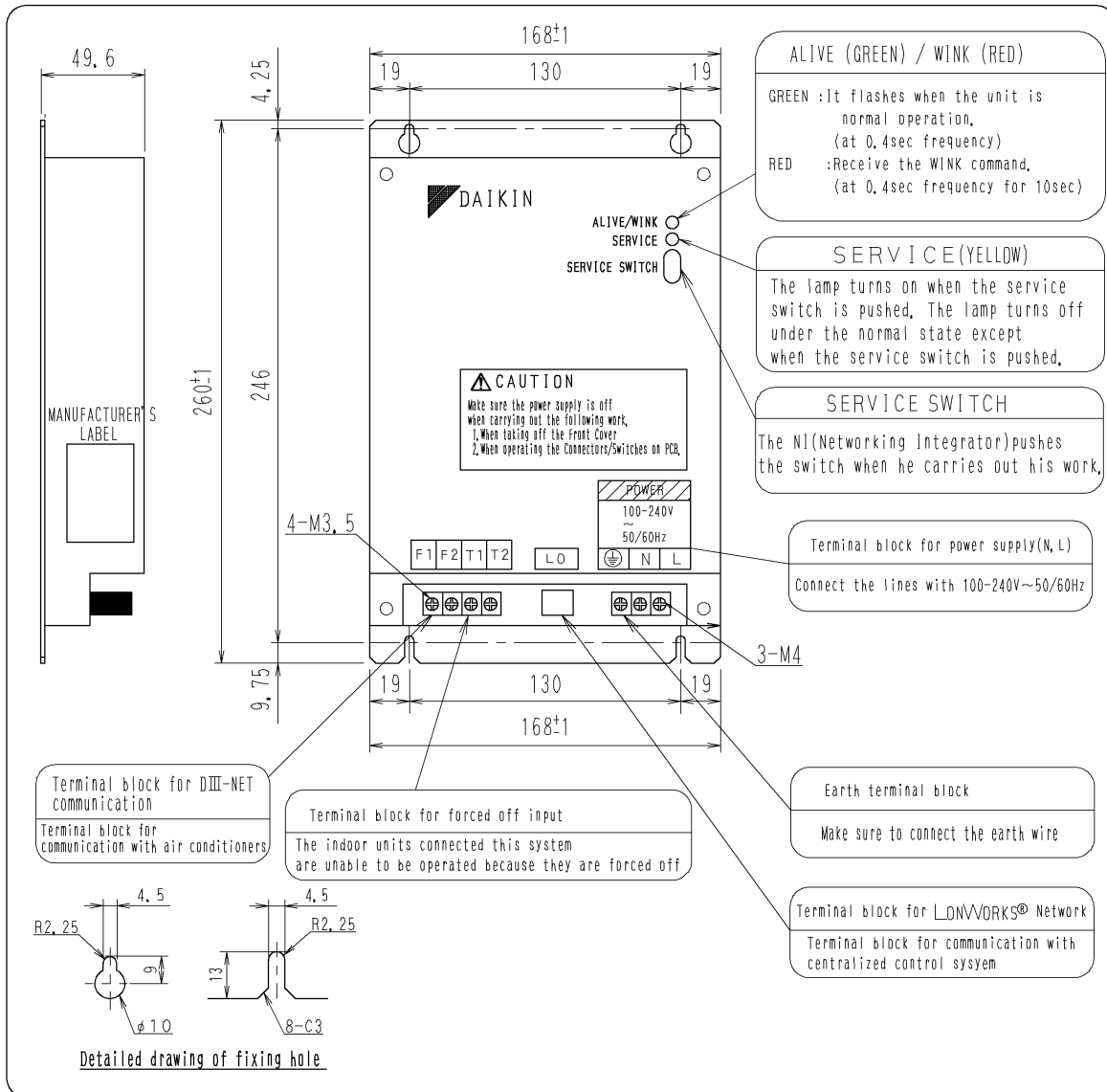

3 Installation

- Make sure to install the unit on the inside of the inaccessible and lockable electrical component box installed indoors where the effect of electromagnetic wave or dust can be avoided. The minimum depth required for installation is 80mm
- Keep the minimum amount of space indicated in the below drawing from walls, and between units when installed in series.
- For installation direction follow the drawing shown below.

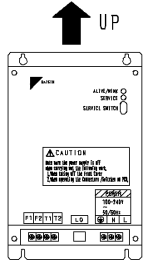

Make sure to install the unit vertically. Do not install the unit horizontally, because it may cause malfunction.

1)Electrical rating	(1)Rated voltage and frequency : Single phase AC100~240V 50/60Hz (2)Rated power consumption : maximum 5W
2)Conditions	(1)Power supply fluctuation : ±10% (2)Ambient temperatyre : -10~+50℃ (3)Ambient humidity : 0~95% (Sweating is not acceptable) (4)Preservation : -20~+60℃
3) Performance	Insulation resistance : 50MΩ or more by DC500 megohmmeter
4)Mass	: 1.5Kg
5)Colour of the unit	: stainless steel sus304-NO.4

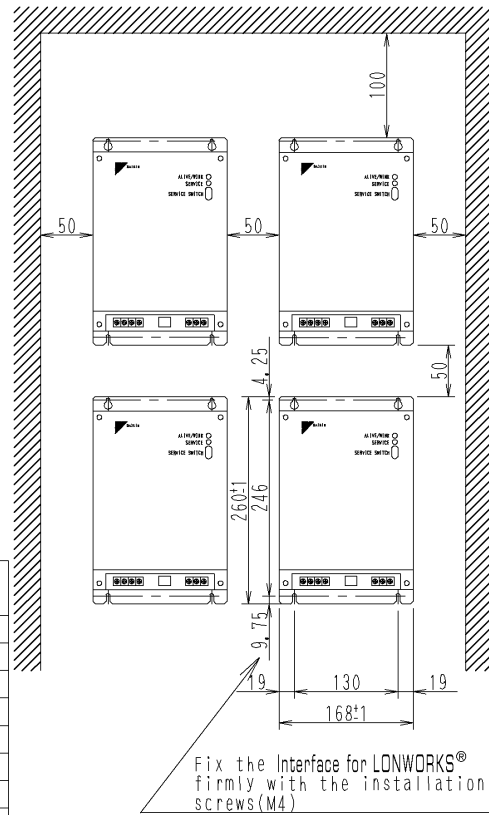

4 Electric Wiring Connection

● Use a round crimp terminal with reinforcing sleeve for safety wiring connection to the Interface for LONWORKS® except the terminal for LONWORKS® Network.

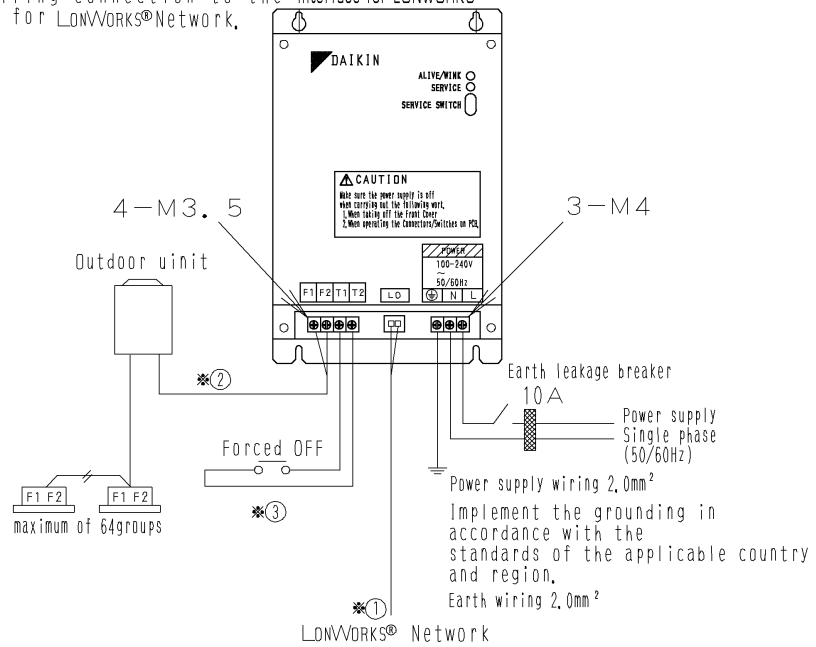

5 Wiring specification

■ Everything relating with field wiring must be supplied in the field.

※① LONWORKS® Network communication wiring
Use the dedicated line for the LONWORKS® Network,

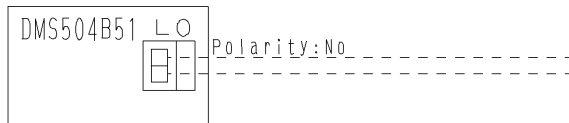

※② DIII-NET wiring

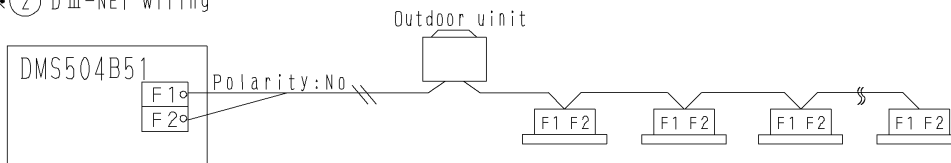

1. Do not use multicore cables with three or more cores.
2. Use wires of sizes between 0.75mm² and 1.25mm²
3. Wire length: Max 1000m

4. Do not bind the wire for DIII-NET
5. Wirings for DIII-NET must be isolated from the power lines.
6. Terminal contact size:M3,5

※③ Forced OFF

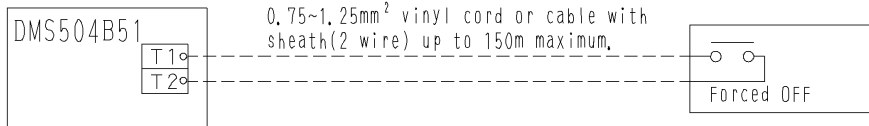

Cautions for wiring

When Forced OFF INPUT is kept on, the indoor units connected this system are unable to be operated because they are Forced OFF.

1. Use a no voltage contact.
2. Use a contact which can guarantee minimum application load DC16V and 10mA.
3. Do not use multicore cables with three or more cores.
4. Wirings must be isolated from the power lines.
5. Terminal contact size:M3,5.

⑥ Names and functions of P.C.B ASSY

① How to open the cover

- Remove the 4 screws as shown in the drawing below

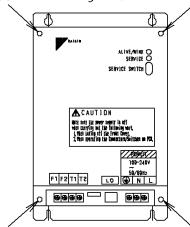

- Slide the cover upward

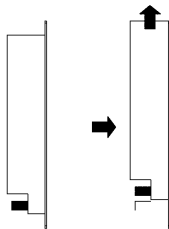

- Lift the cover to the front as shown in the drawing

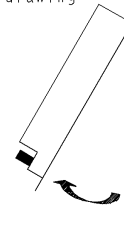

② Names and functions of P.C.B ASSY

Backup battery switch

- Turn ON the switch to bring the backup battery effective. This mark ■ shows the switch position when Interface for LONWORKS® is shipped out of the factory

LED display

LED3 turns on during the battery is charged. Even after the battery is completely charged, the lamp slightly turns on.

LED2 flashes (at 0.4sec frequency) when the CPU for DIII-Net communication is normal.

LED1 flashes when receiving data by DIII-Net communication.

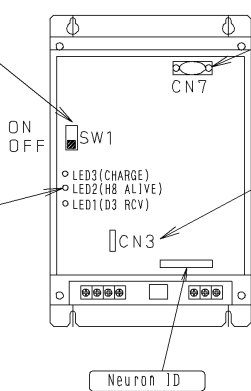

Connector for service PC

- This connector is to be connected to the PC when commissioning is carried out by a service person

Connector for setting the master of centralized control

- The connector must be permanently connected (The connector is connected when shipped out of the factory. Do not pull out the connector)

Since the control substrate is weak to static electricity, do not touch the parts on the substrate. Make sure to discharge static electricity from human body before starting the work. (Static electricity can be discharged by touching the sheet metal of the control panel which is earthed)

7 「DIII-NET master」 setting

Make sure to connect the unit with 「DIII-NET master」

8 Setting the backup battery switch

When shipped out of the factory, the backup battery switch is turned off (the battery is ineffective).

Turn ON the switch for backup of set data such as the information regarding the network variables at power failure.

- Guaranteed hours of power failure, One month (31days)
- The lithium battery is used and is rechargeable.

After the power is restored it is necessary to continuously electrify the battery for approximately one day until the it is completely charged.
(The battery is completely charged when shipped out from the factory.)

9 Setting group No. for centralized control

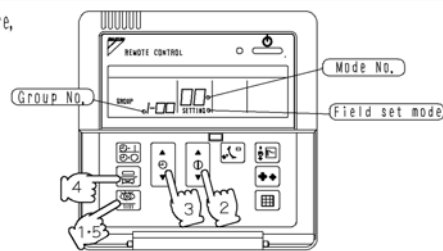

Turn ON the power to the Interface for LONWORKS®. Following the below procedure, set the group numbers for the indoor units connected to the DIII-NET. This group number is set for each indoor unit system.
(When not using the remote controller, the remote controller is to be connected just for making settings but must be disconnected when finished.)







Preparations

- Check no troubles exist with installation and wiring before turning ON the power.
- Turn ON the power to the indoor unit and Interface for LONWORKS®. Setting is not possible with the power OFF.

- Nothing is wrong with the equipment if "BB" is displayed when power is turned ON. This may happen and the unit may not respond to operation, but the situation should last only a moment.

1	Hold down  for 4 seconds or more to enter the field set mode,
2	Press  and set the mode NO. to '00'

3	Press  and set the group No. Group No. increases in the order of 1-00, 1-01 ... 1-15, 2-00, ... 4-15 Set the group No. when "GROUP" on the liquid crystal display is flashing. Press the  button to initiate flashing of "GROUP" on the liquid crystal display.
4	Press  to set the group No.
5	Press  . This will return the system to the normal mode,

• For details on making settings from the simplified remote controller, refer to the instruction manual of the unit.

• For details on making settings of the group No. of the Ventiare or adapters (wiring adapter for other air conditioners, etc.), refer to the instruction manual of the said unit.

Part 9

Troubleshooting

1. Troubleshooting	92
1.1 Alive/Wink Green LED Does Not Blink. Alive/Wink Green LED Blinks, However, H8 Alive LED Does Not.	92
1.2 Communication with the Central Monitoring Panel Can Not be Established. The Service LED Blinks or Lights Up.	93
1.3 Alarm Indication (Error MA, MC, M1) is Displayed During Checking DIII - Net Condition	94
1.4 Test Run.....	95

1. Troubleshooting

1.1 Alive/Wink Green LED Does Not Blink.

Alive/Wink Green LED Blinks, However, H8 Alive LED Does Not.

Trouble Contents

- Alive/Wink Green LED does not blink.
- Alive/Wink Green LED blinks, however, H8 Alive LED does not.

Supposed Causes

- Power is not supplied.
- The power supply voltage is less than rated voltage.

Troubleshooting



Caution

Be sure to turn off power switch before connect or disconnect connector, or parts damage may be occurred.

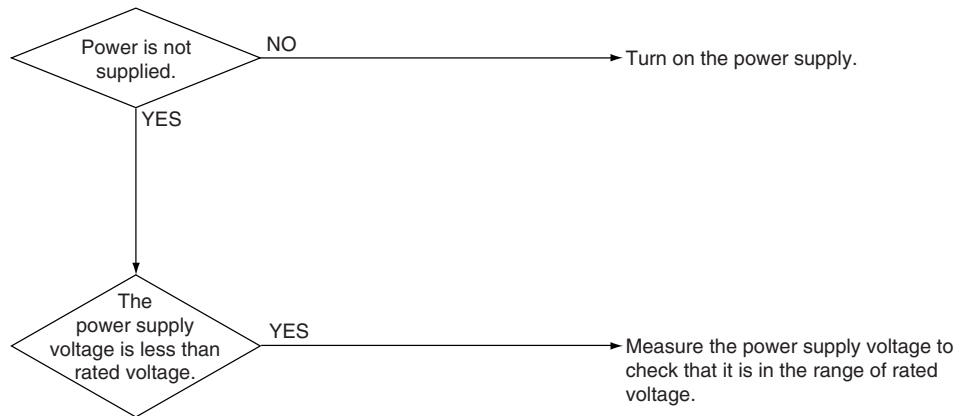

1.2 Communication with the Central Monitoring Panel Can Not be Established. The Service LED Blinks or Lights Up.

- Trouble Contents**
- Communication with the central monitoring panel can not be established.
 - The service LED blinks or lights up.

- Supposed Causes**
- Backup switch is not turned on.
 - Excessively high level noise has been imposed.
 - Faulty hardware.

Troubleshooting



Caution

Be sure to turn off power switch before connect or disconnect connector, or parts damage may be occurred.

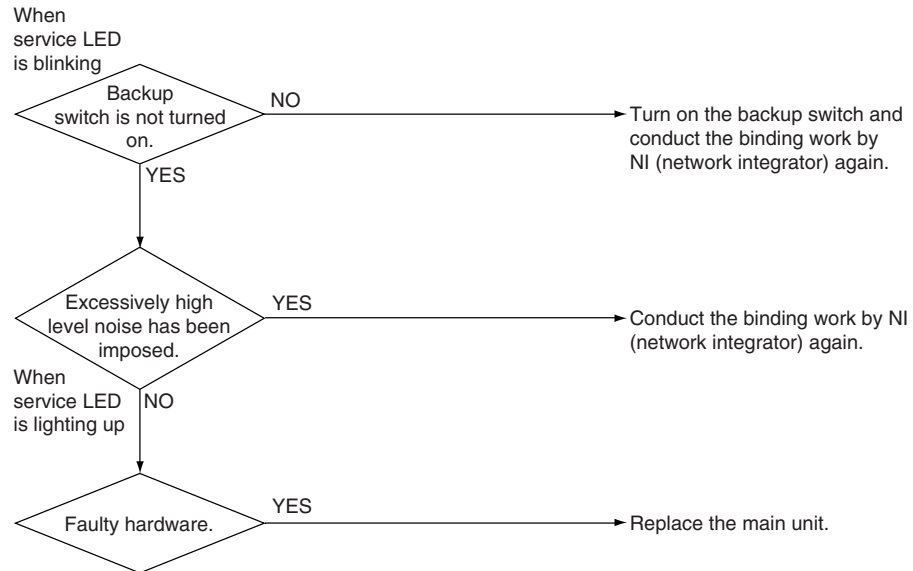

1.3 Alarm Indication (Error MA, MC, M1) is Displayed During Checking DIII - Net Condition

Trouble Contents	<p>During checking DIII-NET condition with test-run tool (Hyperterminal), the following alarm indication is displayed.</p> <ul style="list-style-type: none"> ■ Error MA: Duplicate DIII master ■ Error MC: Duplicate DIII address. ■ Error M1: DIII pole error
Supposed Causes	<ul style="list-style-type: none"> ■ Duplicated master error In case of the unit used with other central control devices, two or more central control devices having connector which is set as master central control device are existing. ■ DIII address is duplicated. Are two or more Interface for LONWORKS® installed on the DIII-NET, or is the Interface for BACnet Gateway not installed? ■ Erroneous DIII-NET polarity judgment

Troubleshooting



Caution

Be sure to turn off power switch before connect or disconnect connector, or parts damage may be occurred.

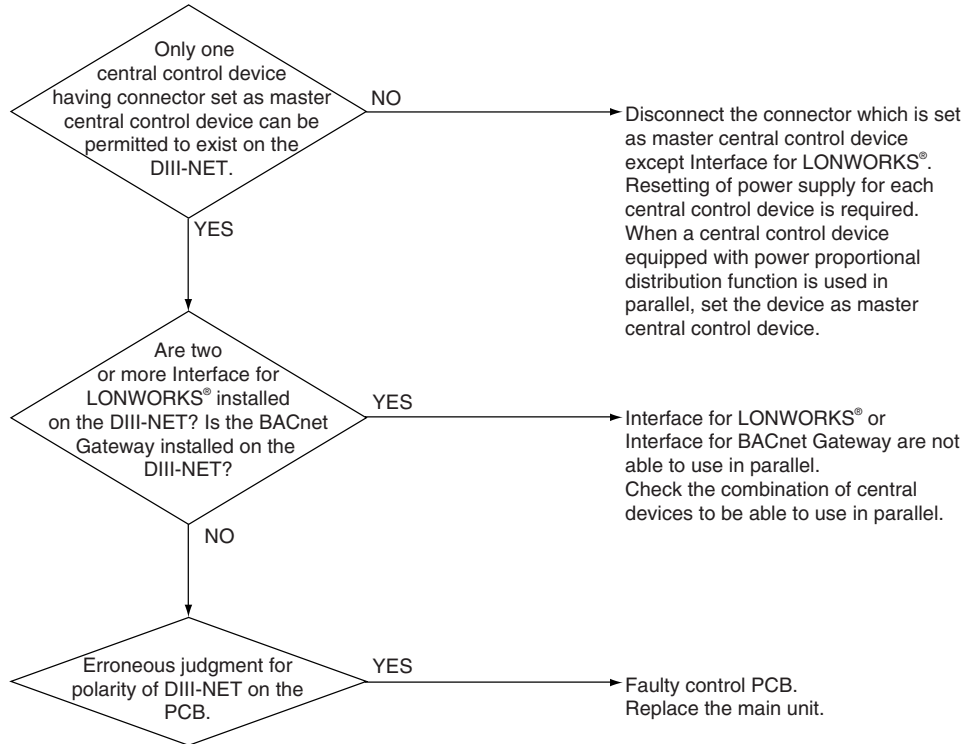

1.4 Test Run

Trouble Contents Commissioning is not available.

Supposed Causes

- Wiring
- Commissioning Tool
- Commissioning Method
- Terminating Resistance

Troubleshooting



Caution Be sure to turn off power switch before connect or disconnect connector, or parts damage may be occurred.

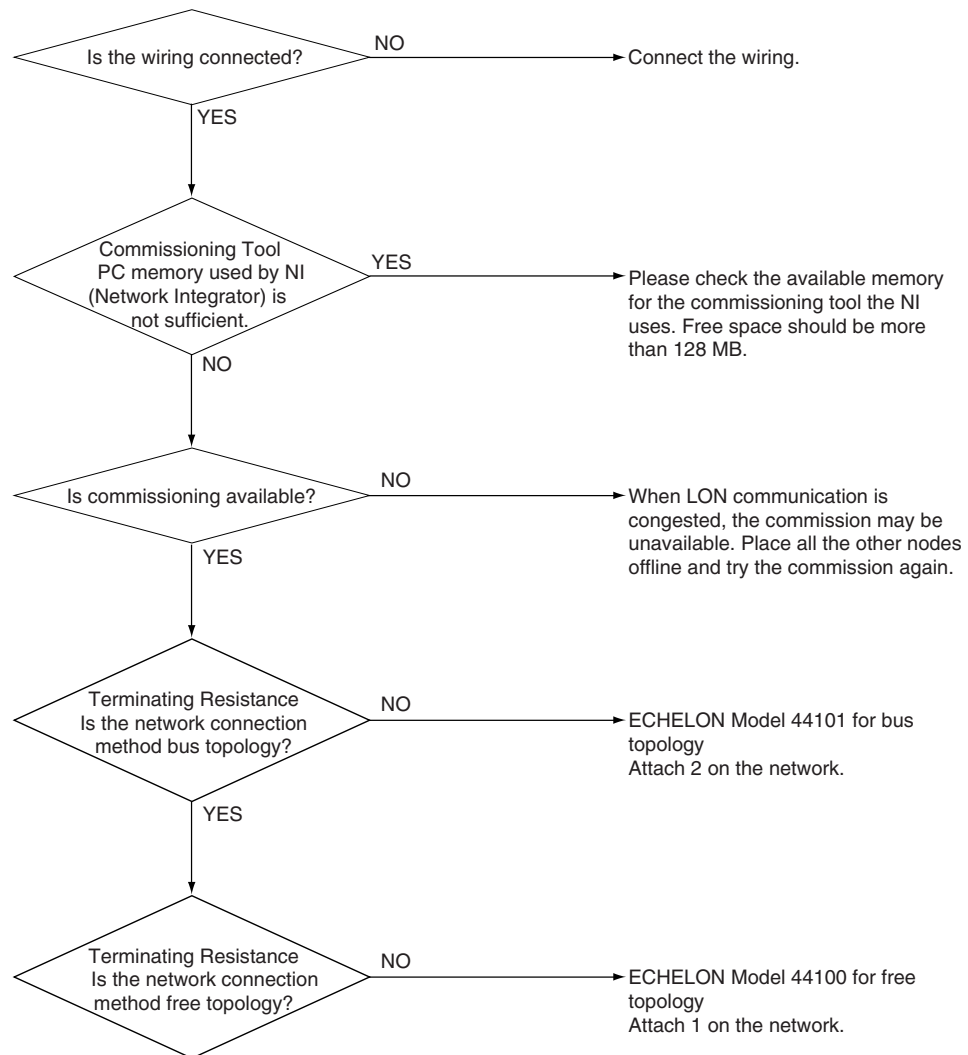

Notes

- *1. Check whether there is terminating resistance in the Interface for LONWORKS®.
- *2. Follow the instructions of Network Integrator about a terminating resistance.

Appendix

[Remarks]

Commission...

- Configures an address (logical address) for each node (equipment) connected to LonWorks networks.

*It is just like configuring central addresses for air conditioners with a remote controller.

- Configures binding information.

*Binding information defines the connection between the networks variables. For example, the Interface for LONWORKS® network variable called the “air conditioner operating information” is connected to another variable of the central monitoring panel called the “air conditioner operating information monitoring.” With this connection, the operational status of the air conditioner can be monitored at the central monitoring panel.

- Configures a table to transfer logical addresses to the physical addresses of the MIP.

*Setting the above information with commission tools such as LonMaker is called commission. The configured data is saved in the Interface for LONWORKS®. If you don't execute battery backup, the data will be lost when the power is turned off, and you will not be able to communicate after that. In this case, you need to commission the device setting again.

1. Combination Table

	Central controller (DCS302A51/B51,61)	Unified ON/OFF (DCS301A51/B51,61)	Schedule Timer (DST301A51/B51,61)	Parallel Interface (DPF201A51)	i-Touch Controller (DCS601A/B51)	intelligent Manager (DMS602A51,52,53)	Interface for BACnet Gateway (DMS502A51)	Interface for LONWORKS® (DMS504B51)	LC 6 (Ainet)
Central controller	OK	OK	OK	OK	OK(*1)	OK	OK	OK	OK
Unified ON/OFF	OK	OK	OK	OK	OK	OK	OK	OK	OK
Schedule Timer	OK	OK	NG	NG	NG	NG	NG	NG	OK
Parallel Interface	OK	OK	NG	NG	OK	NG	NG	NG	OK
i-Touch Controller (DCS601A/B51)	OK	OK	NG	OK	OK	OK	OK	OK	OK
intelligent Manager	OK	OK	NG	NG	OK	NG	NG	NG	OK
Interface for BACnet Gateway	OK	OK	NG	NG	OK	NG	NG	NG	OK
Interface for LONWORKS® (DMS504B51)	OK	OK	NG	NG	OK	NG	NG	NG	OK
LC 6 (Ainet)	OK	OK	OK	OK	OK	OK	OK	OK	NG



The air conditioners manufactured by Daikin Industries have received **ISO 9000 series** certification for quality assurance.

Certificate Number.
(ISO9001) JMI-0107 (ISO9002) JQA-1452
JQA-0495



The airconditioning factories of Daikin Industries have received environmental management system standard **ISO 14001** certification.

Head Office / Tokyo Office
Certificate Number. EC02J0355
Shiga Plant
Certificate Number. EC99J2044
Sakai Plant
Certificate Number. JQA-E80009
Yodogawa Plant
Certificate Number. EC99J2057

Dealer

DAIKIN INDUSTRIES, LTD.

Head Office:
Umeda Center Bldg., 4-12, Nakazaki-Nishi
2-chome, Kita-ku, Osaka, 530-8323 Japan

Tokyo Office:
Shinjuku Sumitomo Bldg., 6-1, Nishi-Shinjuku
2-chome, Shinjuku-ku, Tokyo, 163-0235 Japan

<http://www.daikin.com/global/>

© All rights reserved

• The specifications, designs, and information in this brochure are subject to change without notice.