

Always read before installation.

# AISIN **GEHP** Gas Engine Heat Pump

## GHP OUTDOOR UNIT INSTALLATION INSTRUCTIONS

### F1 Combination Multi Type

#### [Model P450 – P560 – P710 – P850]

#### ■ Applicable Models

Outdoor unit		Specification										
		Mod.	Nat Gas	LPG	G25	DX	AWS standard	AWS low temp	AWS eco	AWS for heat	UTA	EHRE
Combination multi type	<b>P450</b>	AWGP450 F1	N(F)*	P(F)*	G(F)*	X	A	L	E	T	U	K
	<b>P560</b>	AWGP560 F1	N(F)*	P(F)*	G(F)*	X	A	L	E	T	U	K
	<b>P710</b>	AWGP710 F1	N(F)*	P(F)*	G(F)*	X	A	L	E	T	U	K
	<b>P850</b>	AWGP850 F1	N(F)*	P(F)*	G(F)*	X	A	L	E	T	U	K

\* Cold district specification.

#### ■ Notice for the installer

This manual provides the installation procedures and precautions for those with a basic knowledge of AISIN GEHP outdoor units. Improper installation will not realise the unit's full performance potential and could even cause injury or damage to the unit.

Accordingly, read and fully understand the contents of this manual before beginning the installation of the GHP outdoor unit, and install the GHP properly according to the content of this manual. If indoor units, a remote controller or other options, sold separately, are also to be installed, read and fully understand the contents the present manual.





#### Important reminder

- Be sure to check the model code of the GHP outdoor unit before installation. (The model code is written on the plate at the bottom-right position in the rear of the GHP.)
- This unit must be installed by specially trained personnel.
- The installation must be surely performed in accordance with the contents of this manual.
- Perform test operation within 3 months since installation of the GHP on the base and anyway within one year since the delivery

Once installation is completed, always call the local AISIN Authorised Service Centre to perform commissioning.

## ■ Safety precautions

The following symbols are used to indicate precautions that must be observed to prevent possible fatal injuries or damage to the equipment. They are also used to indicate proper instructions, which have to be followed carefully.

 <b>Warning</b>	If the items with this symbol shown in this manual are not adhered to, serious injury or death could occur.
 <b>Caution</b>	If the items with this symbol shown in this manual are not adhered to, injury or damage to the unit could occur.
	This indicates prohibited action.
	This indicates an action or requirement that must be completed.



**TECNOCASA**  
CLIMATIZZAZIONE

Sole European Distributor **AISIN**  
Gas Heat Pump (GHP) / Microcogenerator (MCHP)

# TABLE OF CONTENTS

## I. Before Installation

<b>1. Before Installing</b> .....	<b>4</b>	1-5. Space required for installation .....	8
1-1. Combinations and capacities of the outdoor units and indoor units .....	4	1-6. Foundation and anchor bolt specifications ...	9
1-2. Parts provided .....	5	<b>2. Transporting the Outdoor Unit</b> .....	<b>11</b>
1-3. Locally procured parts .....	5	2-1. Checking the transporting route .....	11
1-4. Selecting the location for installation .....	6	2-2. Methods for transporting the outdoor unit	11
		2-3. Dimensions of outdoor unit (packed state) .....	11

## II. Outdoor Unit Installation and Piping

<b>3. Refrigerant Piping</b> .....	<b>12</b>	3-7. Refrigerant vapor leakage test and vacuuming .....	33
3-1. Schematic diagram of refrigerant piping ...	12	3-8. Charging the refrigerant .....	36
3-2. Refrigerant piping installation specifications .....	13	3-9. Refrigerant piping insulation and heat retention .....	38
3-3. Refrigerant piping - Selecting branch piping and permissible lengths .....	17	3-10. How to secure refrigerant piping .....	39
3-4. Precautions during installation of refrigerant piping .....	27	<b>4. Fuel Gas Piping Installation</b> .....	<b>40</b>
3-5. Notes for branch piping .....	31	<b>5. Drain Pipe Installation</b> .....	<b>41</b>
3-6. Stop valve connections and opening/closing stop valves .....	32	<b>6. How to Extend the Exhaust Pipe</b> .....	<b>44</b>

## III. Electrical Wiring

<b>7. Summary of Electrical Wiring Installation</b> .....	<b>47</b>	8-1. Power supply wire .....	52
7-1. Opening for power supply wires / signal wires .....	47	8-2. Signal wire between indoor-outdoor units, outdoor-outdoor units, and between combined outdoor units .....	53
7-2. Precautions regarding electric wiring connections .....	48	8-3. Remote control wire .....	54
7-3. Wiring example .....	49	<b>9. Power Supply Wiring Procedure</b> .....	<b>55</b>
<b>8. Electrical Wire Specifications and Precautions</b> .....	<b>52</b>	9-1. Wiring instruction .....	55
		9-2. Wiring length .....	57
		9-3. Branch wiring .....	58

## IV. After Installation

<b>10. Reusing existing pipes</b> .....	<b>59</b>	11-7. List of settings and mode numbers .....	66
<b>11. Various Function Settings</b> .....	<b>60</b>	<b>12. Remote Control</b> .....	<b>68</b>
11-1. Address setting method of the indoor and outdoor units .....	60	12-1. Remote control using 2 remote controllers ...	68
11-2. EEP (electronically erasable programmable) dip switch settings .....	60	12-2. Group control .....	68
11-3. Gas type setting .....	63	<b>13. Test Operation</b> .....	<b>69</b>
11-4. Installation of catalyser .....	64	13-1. Before starting test operation .....	69
11-5. Making field settings with the remote controller .....	65	13-2. Sequence of outdoor unit operation following power ON .....	69
		13-3. When installing additional indoor / outdoor units or replacing the indoor / outdoor unit PCBs .....	73

## V. Reference

<b>14. Troubleshooting</b> .....	<b>75</b>	<b>15. Installation Check List</b> .....	<b>79</b>
1. Error code display .....	75		
2. Cancelling the error codes .....	78		

# 1. Before Installing

## 1-1. Combinations and capacities of the outdoor units and indoor units

### Important reminder

- Install the indoor units that correspond to the indoor air conditioning load. Otherwise, the units will frequently repeat start and stop. That could result in breakdown of the units.
- The number and total capacity of the connected indoor units must be within the range shown below. Connecting indoor units in excess of this range could result in breakdown.

### ◆ Combined installation

Outdoor units	Number of connectable indoor units (cold distr)	Total capacity of connectable indoor units (kW)
P450 + P450	63 (53)	144.0 (117.0)
P450 + P560	63 (59)	161.6 (131.3)
P560 + P560	63 (63)	179.2 (145.6)
P560 + P710	63 (63)	203.2 (165.1)
P710 + P710	63 (63)	227.2 (184.6)
P710 + P850	63 (63)	249.6 (202.8)
P850 + P850	63 (63)	272.0 (221.0)

### ◆ Stand-alone installation

Outdoor unit	Number of connectable indoor units (cold distr)	Total capacity of connectable indoor units (kW)
P450	32 (26)	72.0 (58.5)
P560	40 (33)	89.6 (72.8)
P710	52 (41)	113.6 (92.3)
P850	63 (50)	136.0 (110.5)

- In any combination in which the total capacity of the connected indoor units exceeds the capacity of the outdoor unit, the performance of each indoor unit will be lower than its rated capacity when all indoor units are operated simultaneously. Always strive to keep the total capacity of the indoor units within the outdoor unit capacity.
- Connectable indoor units are P22 to P280.

### Important reminder







- In Combined installation, the soft version of Master unit and that of Sub unit must correspond. Otherwise, the units may malfunction.

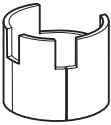

## 1-2. Parts provided

The following parts are provided with this outdoor unit. Verify the contents.

	Name	
	Appearance	
Quantity	1	

	Name					Stopper ring
		Reducer (vapor line)		Reducer (liquid line)		
Appearance/ Q'ty/ Size	P450 P560		1 type, 1 piece (O.D.: 31.8/I.D.: 28.6)		2 types, each 1 piece (I.D.: 15.9/O.D.: 12.7) (O.D.: 15.9/I.D.: 19.1)	 2 pieces
	P710		2 types, each 1 piece (I.D.: 31.8/O.D.: 28.6) (O.D.: 31.8/I.D.: 38.1)		2 types, each 1 piece (I.D.: 15.9/O.D.: 12.7) (O.D.: 15.9/I.D.: 19.1)	
	P850		1 type, 1 piece (O.D.: 31.8/I.D.: 38.1)		2 types, each 1 piece (O.D.: 15.9/I.D.: 19.1) (O.D.: 15.9/I.D.: 22.2)	
Location provided	Inside of refrigerant compartment					Provided with reducer
Notes	Select the proper reducer according to the refrigerant pipe diameter.					-

## 1-3. Locally procured parts



The following items are required for installing this GHP.



### ● Parts required

Part	Application
Anchor bolt	For installing outdoor unit (M12 × 4 pcs)
Washer, nut	For installing outdoor unit (M12 × 4 pcs)
Suspension bolt (M10), nut	For installing indoor units (4 pcs per indoor unit)
Copper pipe (C1220T)	For refrigerant piping (Refer to "3-3. Refrigerant piping - Selecting branch piping and permissible lengths" on page 18)
Hard plastic (PVC: polyvinyl chloride) pipe (VP)	For outdoor unit drain (VP20, VP30, VP50)
Steel pipe (SGP)	For fuel gas piping (3/4 B)
Reinforced gas hose	For fuel gas piping
Insulating material	For refrigerant and drain pipe insulation
Power supply wire	For supplying electrical power for indoor and outdoor units (Refer to "8-1. Power supply wire" on page 53)
Signal wire between indoor and outdoor units	For communication between indoor and outdoor units (Refer to "8-2. Signal wire between indoor-outdoor units, outdoor-outdoor units, and between combined outdoor units" on page 55)
Remote control wire	For connecting indoor unit and remote controller (Refer to "8-3. Remote control wire" on page 56)
Ground wire	For grounding the outdoor unit
Refrigerant	For replenishment charging (R410A)
Refrigerant oil	For applying to the flares (NL10)
Crimp pipe	For header branch pipes
Reducer (for combined installation)	Get appropriate reducers locally.

(Note) Specifications of above listed parts must comply with the relevant local and national regulations and technical standards.

## 1-4. Selecting the location for installation

 <b>Warning</b>	
	<ul style="list-style-type: none"><li>■ <b>Never install the outdoor unit at an indoor location.</b> Doing so causes gas poisoning or an accident due to lack of oxygen.</li><li>■ <b>Never install the outdoor unit at a location where exhaust gas could flow into rooms.</b> If the outdoor unit is installed near the room intake/exhaust ports, windows or ventilation ports, the exhaust gas could flow into the room and cause gas poisoning or an accident due to lack of oxygen.</li><li>■ <b>Never install the outdoor unit in an area where there is any possibility of contact with flammable gasses or volatile flammable materials.</b> Installation at such locations could result in a fire or an explosion.</li></ul>
	<ul style="list-style-type: none"><li>■ <b>Always install the outdoor unit at an outdoor area that is open to the atmosphere.</b> If exhaust gas accumulates, it could cause gas poisoning or an accident due to lack of oxygen. Install the outdoor unit where air flow is sufficient to prevent accumulation of exhaust gasses.</li><li>■ <b>Make sure that ground strength in the area where the outdoor unit is going to be installed is sufficient to withstand the unit's mass.</b> If ground strength is insufficient, the outdoor unit could fall over and cause injury or accident.</li><li>■ <b>Always discharge the exhaust gas to the atmosphere at a location where the gas will not cause adverse affects on the surrounding area.</b> If the exhaust gas is exhausted into a catch basin or ditch, it could be drawn into a room and cause gas poisoning or accident due to lack of oxygen.</li></ul>

 <b>Caution</b>	
	<ul style="list-style-type: none"><li>■ <b>Never install the outdoor unit at a location where its exhaust gas or air from its blower fan will come in contact with plants or animals.</b> The exhaust gas or discharged air could cause harm to plants or animals.</li><li>■ <b>When the outdoor unit is installed on a roof or in a high location, install a permanent ladder or railings along the access path to the unit, and install a fence or railings around the unit for workers.</b> If these facilities are not installed, a worker could fall.</li></ul>



\* If there is no choice of installation location other than where exhaust gas could flow into the room or could cause harm to the surroundings, extend the exhaust pipe. Refer to "6. How to Extend the Exhaust Pipe" on page 46 for details.

#### Important reminder



- Always install the outdoor unit at a location where its operating noise and vibration will not cause problems for people below or in the vicinity of the unit. (This is especially important when installing in residential areas.)
- Install the outdoor unit where exhaust air from the fan does not blow on nearby homes.
- Install the outdoor unit at a level location where rainwater does not penetrate and water does not accumulate.
- Install the outdoor unit at a location where it will not be exposed to strong winds.
- Electrical noise from the outdoor unit may cause adverse effect on other electrical equipment. Always install the unit at a location distant enough from electrical equipment such as televisions, radios, computers, telephones and their antennas, electrical wires, and signal wires.
- Install the outdoor unit at a location where heat from other equipment does not cause adverse effect on the unit.
- If the outdoor unit is installed in a heavy snowfall area, install the unit where accumulated snow can not fall on the unit, and install the optional snow hood as well. Also make sure that the foundation for the unit is high enough so as not to be affected by accumulated snow.
- Allocate a route for loading/unloading the equipment, materials and parts for maintenance at the installation site (minimum route width: 1200 mm, maximum mass of equipment, materials and parts:250 kg).
- Do not install the outdoor unit at a location where fallen leaves accumulate.

## 1-5. Space required for installation

### 1) Provide sufficient distance from flammable materials

 <b>Warning</b>	
	<p>■ <b>Install the outdoor unit at the proper distance from flammable items as required by the relevant local and national regulations and technical standards.</b></p> <p>If the distance does not meet the requirements, it could result in a fire.</p>

### 2) Installation space

 <b>Caution</b>	
	<p>■ <b>The following drawings show the minimum installation space for providing room for intake air and inspection and maintenance operations.</b></p> <p>Insufficient space could result in injury to maintenance personnel or damage to the equipment.</p>

Provide ample space for inspection and maintenance taking the refrigerant and fuel gas piping into account.

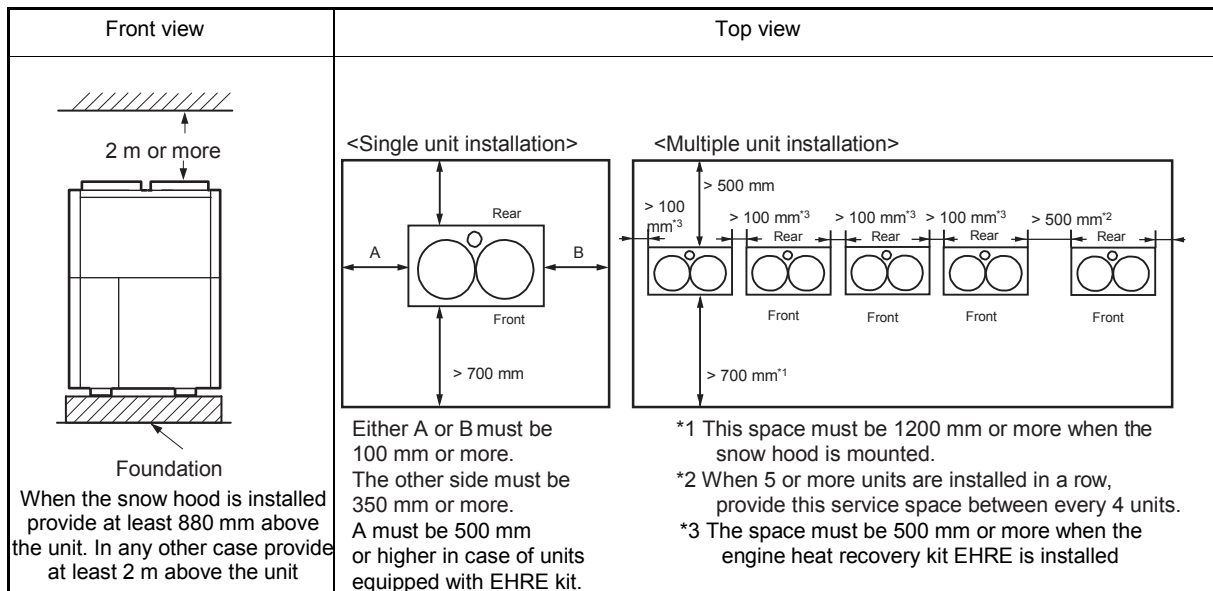

#### Important reminder

- **When 4 or more of outdoor units are installed in the same location, nearby walls or other objects could obstruct air flow, causing it to short circuit. To prevent a decline in performance and trouble due to short circuited airflow, larger installation space is necessary. Contact an authorized dealer for details.**
- **When outdoor units are equipped with engine heat recovery kit (EHRE), provide enough space on the left side to allow routing of water pipes.**

# 1-6. Foundation and anchor bolt specifications

## 1) Foundation shape

**Warning**

■ **The foundation must provide a firm and level surface for installing the outdoor unit so that the outdoor unit does not tip over in the event of strong winds (gust, etc.) or earthquakes.**

If the foundation strength is insufficient, the outdoor unit could tip over and cause fuel gas leakage or injury.

- The foundation must have sufficient strength in accordance with the drawings below. In order to protect the outdoor unit from rain, dust and damage, the height of the foundation must be 200 mm from the ground. The foundation must be surrounded by channels that direct drain water to a drainage port.
- The foundation must support the mass of the outdoor unit evenly and must be flat and smooth so that water can not accumulate on the upper surface.
- Never use a foundation that consists of more than one block. Such a foundation will not provide the required strength.
- When installing an all-in-one foundation, which consists of more than one piece of block, on the rooftop floor, etc, be sure to note the strength.
- Condensed water may drip from the bottom of the outdoor unit. Install a drain pan if condensation could cause problems.

<Ground installation>

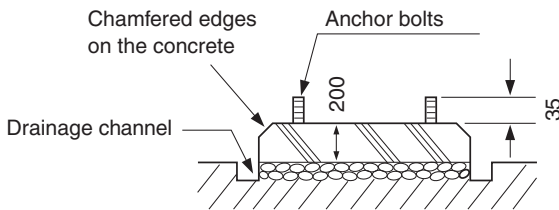

<Roof-top installation>

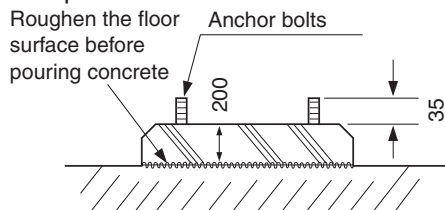

<Foundation dimensions>

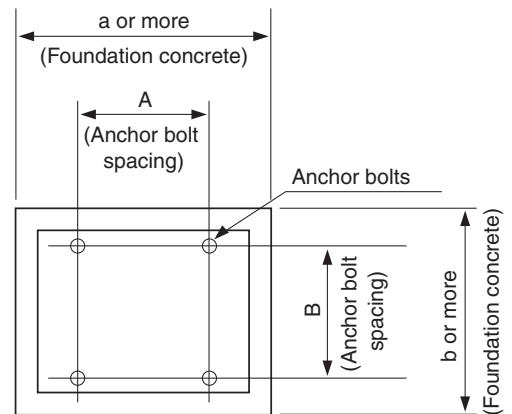

Length: mm

Installation location/ Earthquake design resistance	Foundation dimensions (mm)		Anchor bolt spacing (mm)	
	a	b	A	B
Ground/ Horizontal 0.4 G, Vertical 0.2 G	1750	1100	841	956
Roof-top/ Horizontal 1.0 G, Vertical 0.5 G	1850	1700	841*	956*

\* Refer to "1-6. 3) Antivibration mount" on page 11 when installing the antivibration mount.

### Important reminder

- **If the foundation is smaller than the specified dimensions or if the designed earthquake resistance value needs to be higher than that shown in the table above, appropriate design change such as connecting the foundation to the building (floor slab) with steel rods is necessary. Such design changes should be done in accordance with the appropriate building equipment seismic tolerance design and installation policy.**

## 2) Anchor bolts

### Warning



**Use anchor bolts that satisfy the specifications shown in the table below. Make sure the legs of the outdoor unit are firmly secured with washers and bolts.**

If the strength is insufficient, the unit could tip over and cause fuel gas leakage or injury.

Required anchor bolt pull out resistance strength

Size	M12
Short-term permissible pull-out load	6.7 kN or more
Type	<ul style="list-style-type: none"> <li>• Male-style concrete anchor</li> <li>• Resin anchor</li> <li>• Embedded anchor</li> </ul>

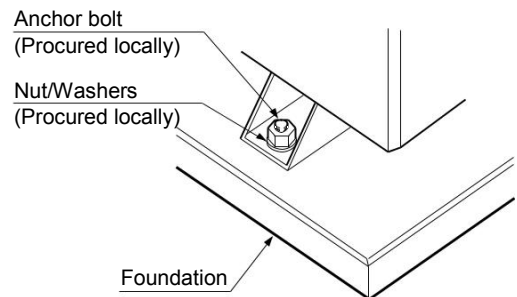

- Never use female style concrete anchors because their pull out resistance strength is insufficient.
- The tightening torque of the anchor bolt conforms to the value recommended by the anchor bolt manufacturer.

## 3) Antivibration mount

### Important reminder

**When using an anti-vibration mount to install the unit, check the relevant local and national regulations and technical standards, and make sure that the installation complies with building regulations and relevant installation policy.**

- Use an anti-vibration mount when operating noise or vibration could cause problems in lower floors or nearby rooms as a result of installing the outdoor unit on a roof or balcony. (For specific information about installing, refer to the manual provided with the antivibration mount.)
- When using the anti-vibration mount, refer to the table below for the spacing of the anchor bolts in the foundation.
- Provide drain channels as required the top of the foundation as necessary to prevent water from accumulating inside the lower frame of the antivibration mount.
- The foundation must be of one piece. Make the foundation's upper surface level, flat and smooth so that the lower frame of the antivibration mount can make uniform contact.
- The tightening torque of the antivibration mount conforms to the value recommended by the anchor bolt manufacturer.

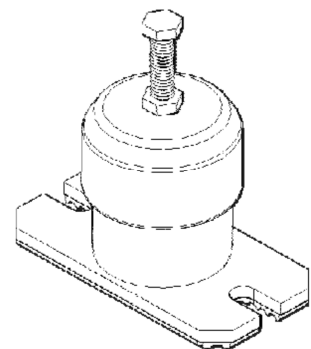

## 2. Transporting the Outdoor Unit

### 2-1. Checking the transporting route

- Make sure that the route to the installation site and any openings are large enough for the outdoor unit to be transported through.
- Make sure that the route surface to the installation site has the strength to withstand the weight of the outdoor unit.

### 2-2. Methods for transporting the outdoor unit

- Use nylon slings rigged in the manner shown in the illustration below. Protect the outdoor unit as to prevent damage or deformation. Take care to avoid pinching the refrigerant piping or exhaust water drain hoses.

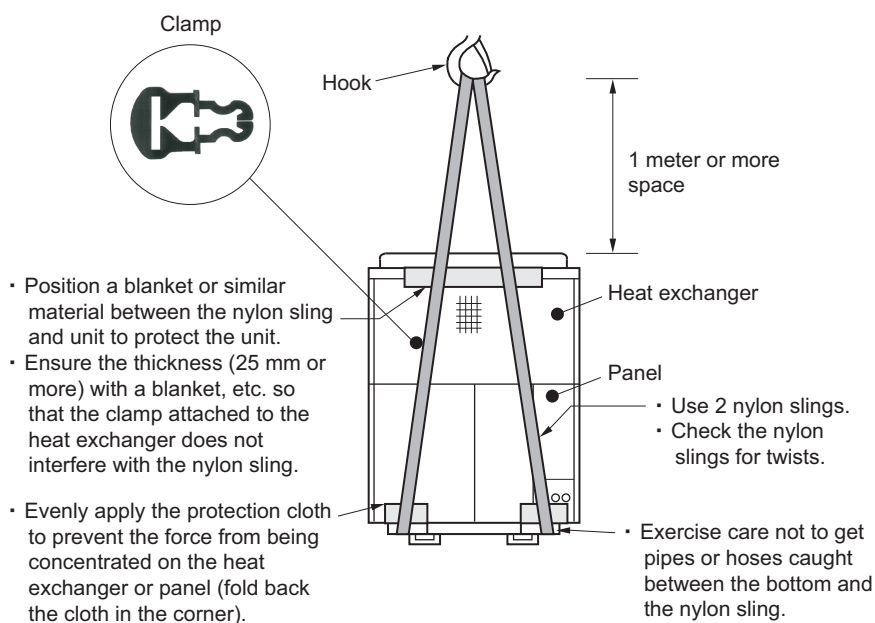

- If a forklift is used for transport, spread the forks as wide as possible so that they fit in the opening at the bottom of the unit (as shown in the illustration below). Insert the forks completely, taking care not to damage the unit with the forks.

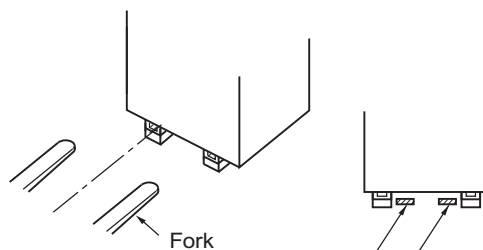

- Do not tilt the unit more than 30°. (Never tip the unit on its side)

### 2-3. Dimensions of outdoor unit (packed state)

Outdoor unit	Package dimensions (mm)	Package weight (kg)
P450	1800 (W) × 1070 (D) × 2360 (H)	795
P560		795
P710		825
P850		895

# 3. Refrigerant Piping

## 3-1. Schematic diagram of refrigerant piping

### ◆ Combined installation

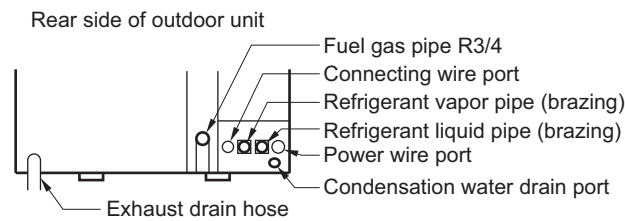
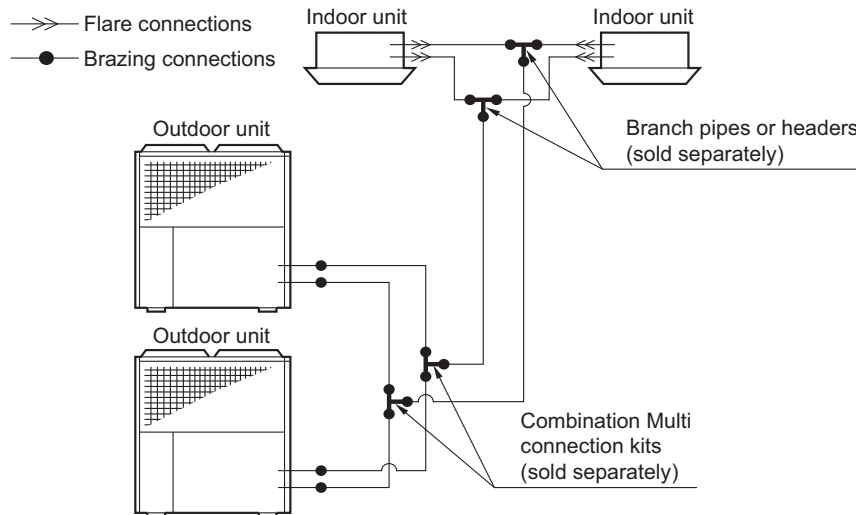

### ◆ Stand-alone installation

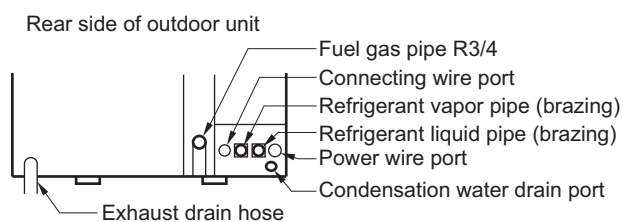
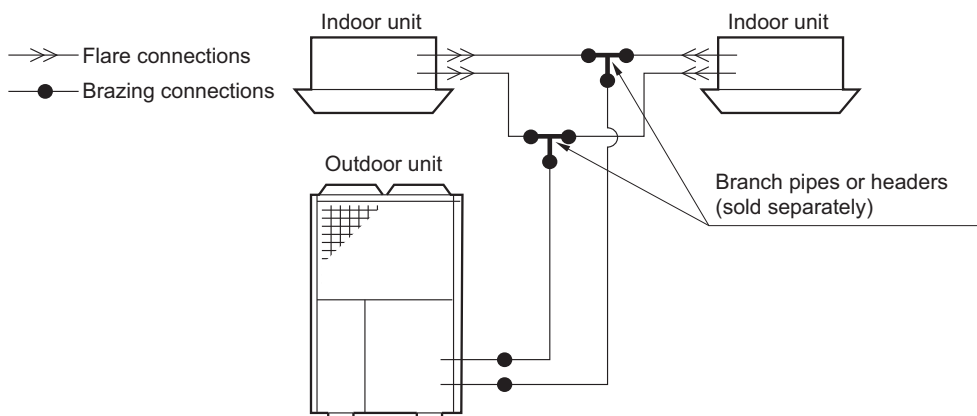



### 3-2. Refrigerant piping installation specifications

- Follow the restrictions shown in the table below when installing new refrigerant piping.

#### ◆ Combined installation

Outdoor unit	Item							
	Outdoor unit Refrigerant piping diameter (mm)		Refrigerant piping diameter (mm) between outdoor unit and Combination Multi connection kit		Permissible piping length (m) Equivalent length / Actual length	Permissible height difference (m)		Refrigerant oil
	Vapor line	Liquid line	Vapor line	Liquid line		Outdoor unit is higher	Outdoor unit is lower	
P450 P560	ø31.8	ø15.9	ø28.6	ø15.9	190/165	50	40	NL-10
P710			ø31.8					
P850			ø19.1					

	Refrigerant main piping diameter (mm)	
	Vapor line	Liquid line
P450 + P450 P450 + P560 P560 + P560 P560 + P710 P710 + P710	ø38.1	ø19.1 (ø22.2)*
P710 + P850 P850 + P850	ø38.1 (ø44.5)*	ø22.2

\* If the piping length exceeds 100 m, install pipes that are larger by one rank as specified in ( ).

#### ◆ Stand-alone installation

Outdoor unit	Item							
	Outdoor unit Refrigerant piping diameter (mm)		Refrigerant main piping diameter (mm)		Permissible piping length (m) Equivalent length / Actual length	Permissible height difference (m)		Refrigerant oil
	Vapor line	Liquid line	Vapor line	Liquid line		Outdoor unit is higher	Outdoor unit is lower	
P450 P560	ø31.8	ø15.9	ø28.6 (ø31.8)*	ø15.9 (ø19.1)*	190/165	50	40	NL-10
P710			ø31.8 (ø38.1)*					
P850			ø19.1 (ø22.2)*					

\* If the piping length exceeds 100 m, install pipes that are larger by one rank as specified in ( ).

## ■ Reducer selection for combined installation

### ◆ Combined installation

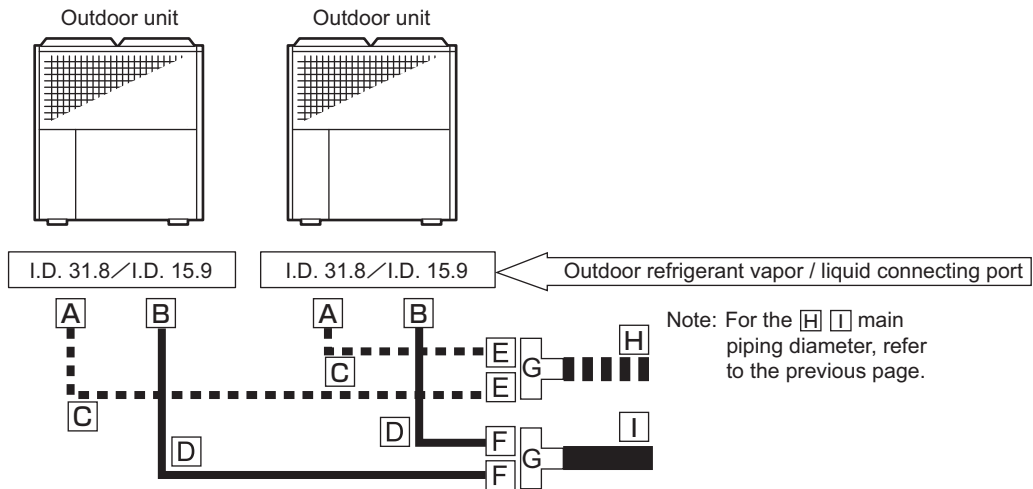

Outdoor unit	Reducer in outdoor unit connecting port side (Provided with the outdoor unit)		Copper piping between outdoor unit and connection kit (Procured locally)		Reducer in connection kit side		Connection kit (Option)
	<b>A</b> <Vapor line>	<b>B</b> <Liquid line>	<b>C</b> <Vapor line>	<b>D</b> <Liquid line>	<b>E</b> <Vapor line>	<b>F</b> <Liquid line>	
P450 P560	O.D. 31.8 I.D. 28.6	-	ø28.6	ø15.9	For the reducer in the connection kit side, use the product provided with the outdoor unit or connection kit (option).		KHRPMULTIF KHRP26A75T (Note 1)
P710	-	-	ø31.8				
P850	-	O.D. 15.9 I.D. 19.1		ø19.1			

Note1 Used when P710 + P850 and P850 + P850 are combined.

### ◆ Stand-alone installation

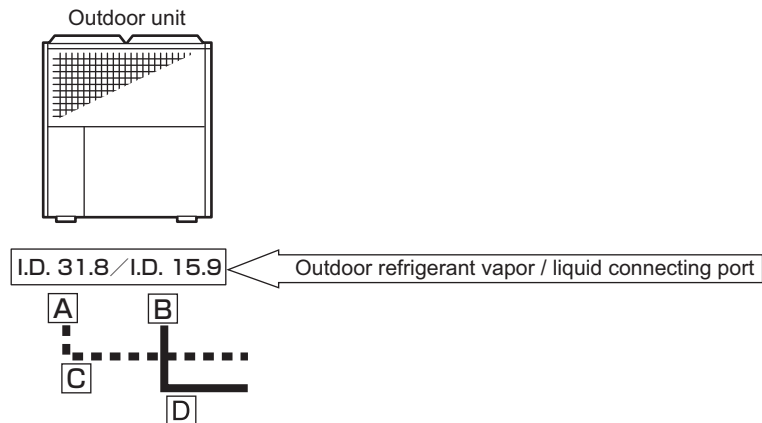

<If the refrigerant piping equivalent length exceeds 100 m>

Outdoor unit	Reducer in outdoor unit connecting port side (Provided with the outdoor unit)		[Main piping] Copper piping (Procured locally)		Outdoor unit	Reducer in outdoor unit connecting port side (Procured locally)		[Main piping] Copper piping (Procured locally)	
	<b>A</b> <Vapor line>	<b>B</b> <Liquid line>	<b>C</b> <Vapor line>	<b>D</b> <Liquid line>		<b>A</b> <Vapor line>	<b>B</b> <Liquid line>	<b>C</b> <Vapor line>	<b>D</b> <Liquid line>
P450 P560	O.D. 31.8 I.D. 28.6	-	ø28.6	ø15.9	P450 P560	-	O.D. 15.9 I.D. 19.1	ø31.8	ø19.1
P710	-	-	ø31.8		P710	O.D. 31.8 I.D. 38.1	O.D. 15.9 I.D. 22.2	ø38.1	
P850	-	O.D. 15.9 I.D. 19.1		ø19.1	P850				ø22.2

■ Precautions for combined installation

**Caution**

■ **If the refrigerant oil accumulates in the refrigerant piping between the outdoor units, it causes a unit failure.**  
Thoroughly read “Precautions for combined installation”, and be sure to follow them.

- Arrange the refrigerant piping for both liquid and vapor between the outdoor units so that the piping is level or has upward gradient to prevent the refrigerant oil from accumulating in the piping.

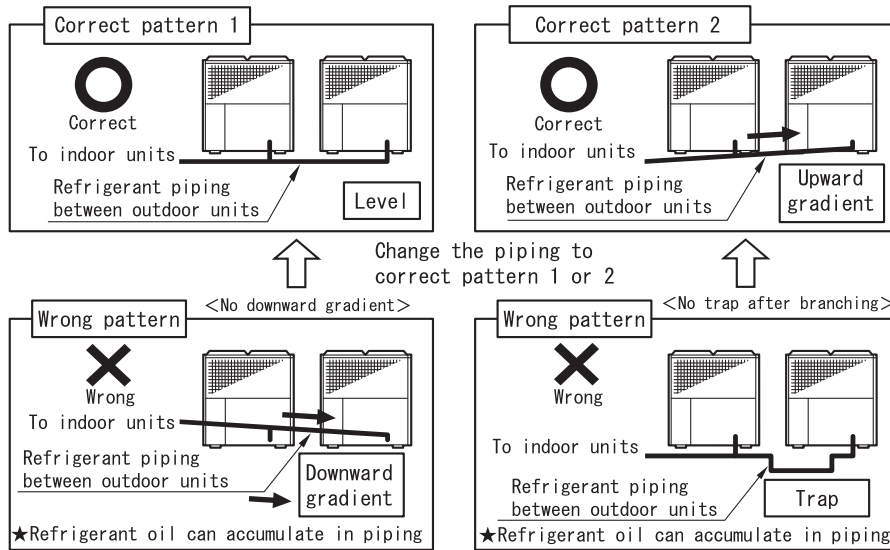

- Connect the refrigerant piping between the outdoor units to the stop valve as shown in the following figure A or B. Otherwise, the refrigerant oil can accumulate in the piping.

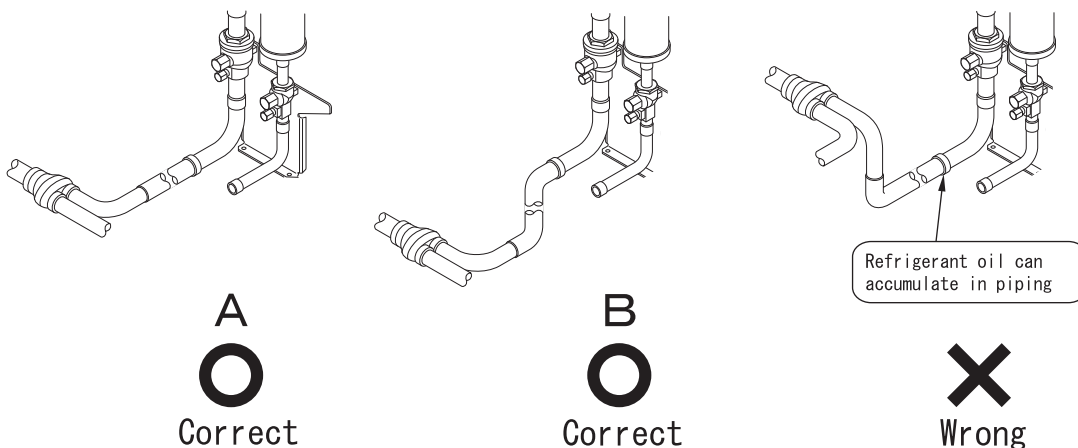

- Be sure to install the Combination Multi connection kit “horizontally” for both vapor and liquid.

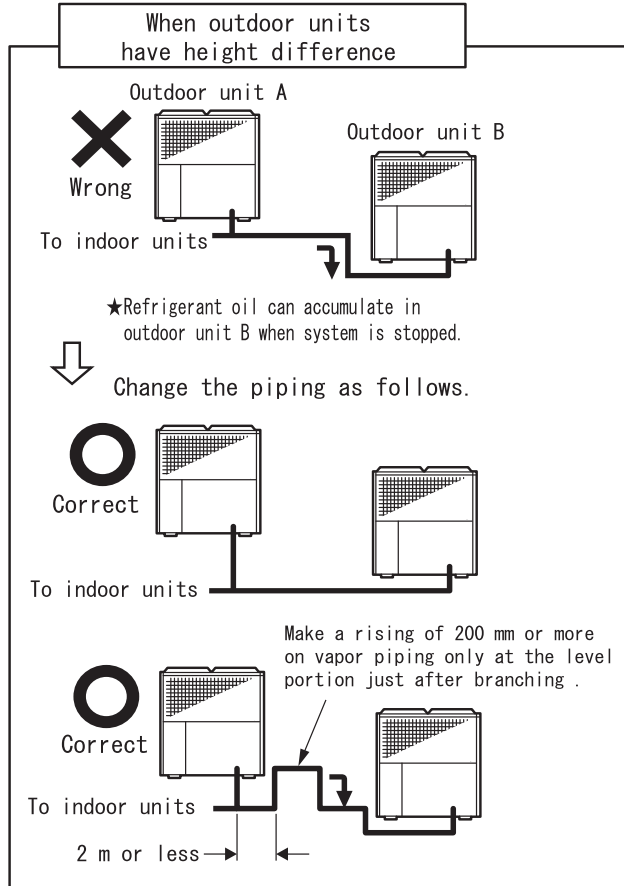
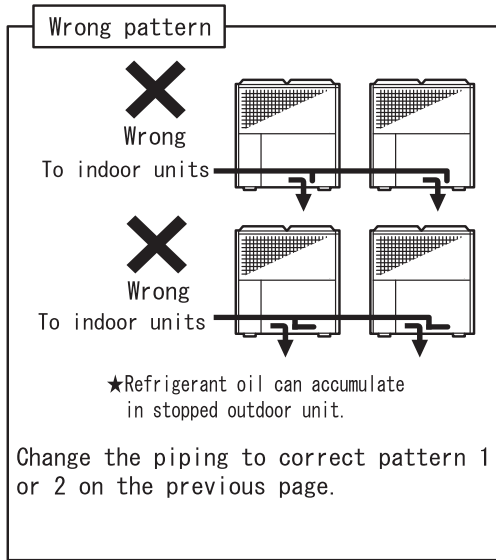
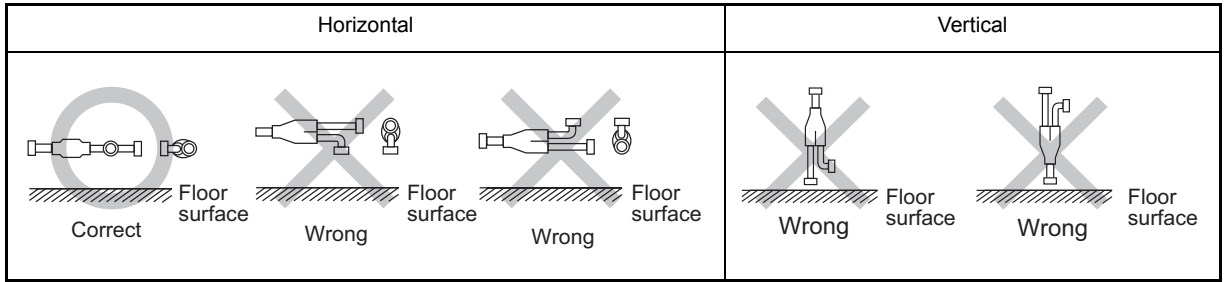

- Make straight portion of 660 mm or more before branching of the Combination Multi connection kit.

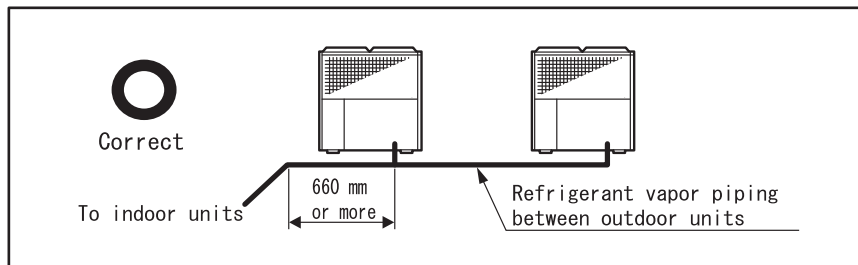

- When the piping length from the Combination Multi connection kit to the outdoor unit is 2 m or more, make a rising of 200 mm or more on vapor piping only at a location 2 m or less from the Combination Multi connection kit.

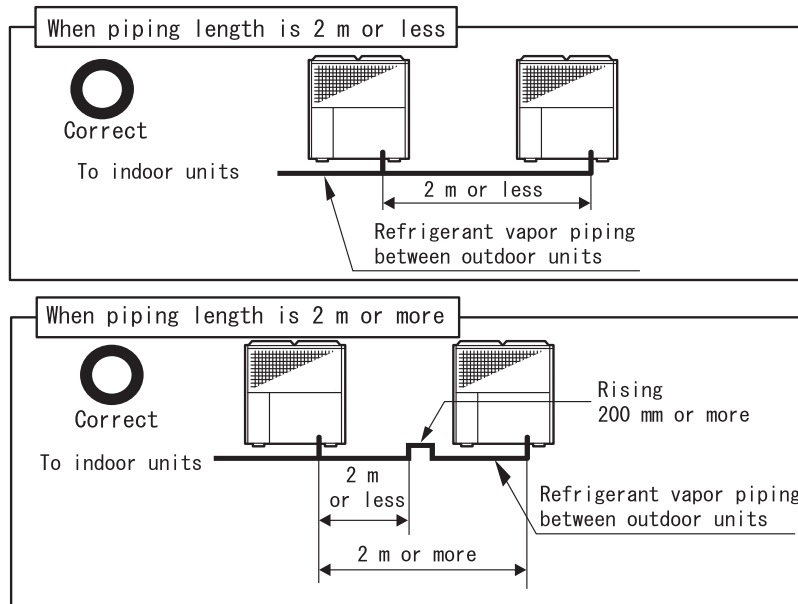

### 3-3. Refrigerant piping - Selecting branch piping and permissible lengths

\* Follow the piping specification shown below when installing new refrigerant piping.

- Make sure that the total extension refrigerant piping length is 520 m or less.
- If the refrigerant piping equivalent length exceeds 100 m,

Stand-alone installation	P450, P560, P710, P850	Both the liquid line and vapor line of the main piping
Combined installation	P710 + P850, P850 + P850	Vapor line only of main piping
	Others	Liquid line only of main piping

Use pipes with diameters that are larger by one rank.

Example:  $\varnothing 19.1 \rightarrow \varnothing 22.2$

- This unit uses R410A. Limit pressure of O material pipe with  $\varnothing 19.1$  diameter or larger is insufficient. Be sure to use 1/2H or H material pipes with minimum thickness or thicker. For  $\varnothing 19.1$  pipe only, however, as long as the thickness is 1.05 mm or thicker, O materials can be used.
- Do not use bent pipe with an external diameter of  $\varnothing 28.6$  or larger.
- Any of line branching, header branching, and line-header combined branching can be used with refrigerant piping. Select the appropriate method according to the layout of indoor units.
- Refrigerant piping length and the height difference between indoor units should be minimized to the extent possible.
- Re-branching after header branching is not allowed.

## ■ Piping specifications (Use the following pipes)

- Piping material: Phosphate deoxidized copper seamless air-conditioning pipe JIS (Japanese Industrial Standards) H3300, C1220T (Japanese technical standard) or equivalents.
- Refrigerant pipe specifications: Outer diameter × thickness (mm)
 

ø6.4 × 0.8 (O material or OL material)	ø9.5 × 0.8 (O material or OL material)
ø12.7 × 0.8 (O material or OL material)	ø15.9 × 1.0 (O material or OL material)
ø19.1 × 1.0 (1/2H or H material) *1	ø22.2 × 1.0 (1/2H or H material)
ø25.4 × 1.0 (1/2H or H material)	ø28.6 × 1.0 (1/2H or H material)
ø31.8 × 1.1 (1/2H or H material)	ø38.1 × 1.35 (1/2H or H material)
ø44.5 × 1.4 (1/2H or H material)	

\*1 For ø19.1 pipe only, as long as the thickness is 1.05 mm or greater, O materials can be used.

(Note) Refrigerant piping diameter must not exceed the outdoor unit main piping diameter.

## ◆ Combined installation

(1) Piping between outdoor unit and Combination Multi connection kit (X and Y)			
Outdoor unit	P450, P560	P710	P850
Vapor line (mm)	ø28.6		ø31.8
Liquid line (mm)	ø15.9		ø19.1

(2) [Main piping] Between Combination Multi connection kit and first branch (A)		
Total capacity of outdoor unit (kW)	90.0 to 142	156 to 170
Vapor line (mm)	ø38.1	ø38.1 (ø44.5)*
Liquid line (mm)	ø19.1 (ø22.2)*	ø22.2

\* If the refrigerant piping equivalent length exceeds 100 m, use pipes with the [diameter indicated in ( )].

Note The piping diameter of the first branch and after must not exceed the diameter of the outdoor unit main piping.

(3) Piping between branches (B and C)						
Total capacity (kW) of indoor units downstream from each branch	Less than 22.4	22.4 or more and less than 33.0	33.0 or more and less than 47.0	47.0 or more and less than 71.0	71.0 or more and less than 104	104 or more
Vapor line (mm)	ø15.9	ø22.2	ø28.6		ø31.8	ø38.1
Liquid line (mm)	ø9.5		ø12.7	ø15.9	ø19.1	

(4) Piping between branch and indoor unit (a, b, c, d, e, or f)				
* Indoor units of type P280 or later cannot be connected to the header branch (c, d, e, or f).				
Indoor unit	P22, 28, 36, 45, 56	P71, 80, 90, 112, 140, 160	P224	P280
Vapor line (mm)	ø12.7	ø15.9	ø19.1	ø22.2
Liquid line (mm)	ø6.4			

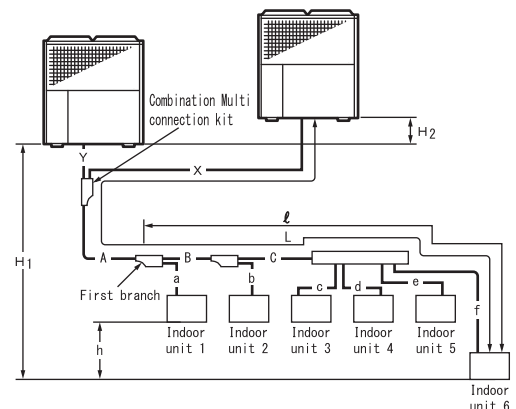

## ◆ Stand-alone installation

(1) [Main piping] Between outdoor unit and first branch (A)			
Outdoor unit	P450, P560	P710	P850
Vapor line (mm)	ø28.6 (ø31.8)*		ø31.8 (ø38.1)*
Liquid line (mm)	ø15.9 (ø19.1)*		ø19.1 (ø22.2)*

\* If the refrigerant piping equivalent length exceeds 100 m, use pipes with the [diameter indicated in ( )].

\* The piping diameter of the first branch and after must not exceed the diameter of the outdoor unit main piping.

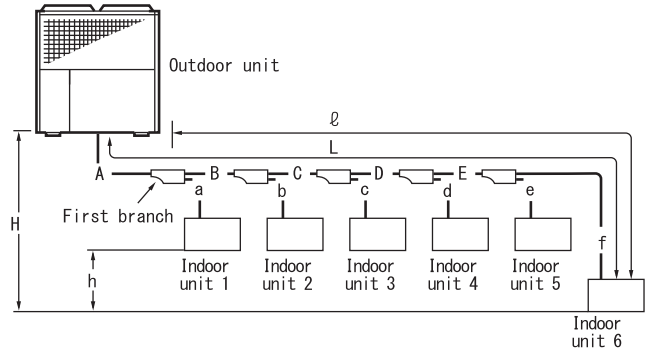

(2) Piping between branches (B and C)						
Total capacity (kW) of indoor units downstream from each branch	Less than 22.4	22.4 or more and less than 33.0	33.0 or more and less than 47.0	47.0 or more and less than 71.0	71.0 or more and less than 104	104 or more
Vapor line (mm)	ø15.9	ø22.2	ø28.6		ø31.8	ø38.1
Liquid line (mm)	ø9.5		ø12.7	ø15.9	ø19.1	

(3) Piping between branch and indoor unit (a, b, c, d, e, or f)				
* Indoor units of type P280 or later cannot be connected to the header branch (c, d, e, or f).				
Indoor unit	P22, 28, 36, 45, 56	P71, 80, 90, 112, 140, 160	P224	P280
Vapor line (mm)	ø12.7	ø15.9	ø19.1	ø22.2
Liquid line (mm)	ø6.4		ø9.5	

Note If the piping sizes are different between the outdoor unit and indoor unit in 1:1 connection, apply the main piping size. (Attach the pipe of a different diameter to the indoor unit side to make adjustments.)

■ Branch piping selection and permissible piping length

◆ Line branching [Combined installation]

**Important**

- If there is a height difference between the locations of indoor and outdoor units, be sure to include traps in the vapor line at intervals of no more that 10 m as illustrated.

Layout example  
(When 6 indoor units are connected)

Note X: 10 m or less  
Y: 10 m or less  
H<sub>1</sub>: See below  
H<sub>2</sub>: 4 m or less

Permissible piping length	Maximum piping length (L)* (Equivalent length/ Actual length)	$X + A + B + C + D + E + f$	190/165 m or less
	Maximum piping length after the first branch ( $l$ )	$B + C + D + E + f$	90 m or less
	Difference between maximum piping length after the first branch ( $l$ ) and the length of the first branch (a) (when "a" is the shortest length after the first branch)	$l - a$	70 m or less
Permissible height difference	Maximum height difference between indoor units and outdoor units (H <sub>1</sub> )	When outdoor units are higher than indoor units	50 m or less
		When outdoor units are lower than indoor units	40 m or less
	Maximum height difference between indoor units (h)	$35 - \frac{(l - a)}{2}$ m or less However, $0 \leq h \leq 15$	

Branch piping	Selection of Combination Multi connection kit	P710 + P850, P850 + P850	KHRP26A75T
		Others	KHRPMULTIF

How to select the branch piping kit (line branch)

Since the size of branching pipe varies depending on the total capacity of indoor units downstream from the branch, refer to the following table to select the branch piping kit.

	Classification	Model
First branch for outdoor unit capacity (kW)	90.0 - 142	KHRP26M73T
	156 - 170	KHRP26A75T
Second branch and after for total downstream indoor unit capacity (kW)	Less than 22.4	KHRP26M22T
	22.4 or more and less than 33.0	KHRP26M33T
	33.0 or more and less than 71.0	KHRP26M72T
	71.0 or more	KHRP26M73T

Important reminder:

- Be sure to use the indoor unit piping and indoor branch piping that correspond to the indoor unit connection piping size.
- Always install branch piping joints (for both vapor and liquid) so that the joint branches are either horizontally or vertically oriented. (Refer to "3-5. Notes for branch piping" on page 32.)

\* In case total connected capacity exceeds 130% of rated capacity, restrict actual length to 100 m



## ◆ Line branching [Stand-alone installation]

### Important

- If there is a height difference between the locations of indoor and outdoor units, be sure to include traps in the vapor line at intervals of no more than 10 m as illustrated.

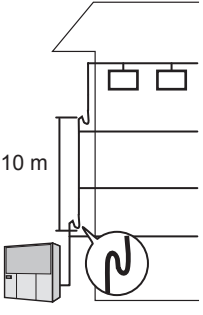
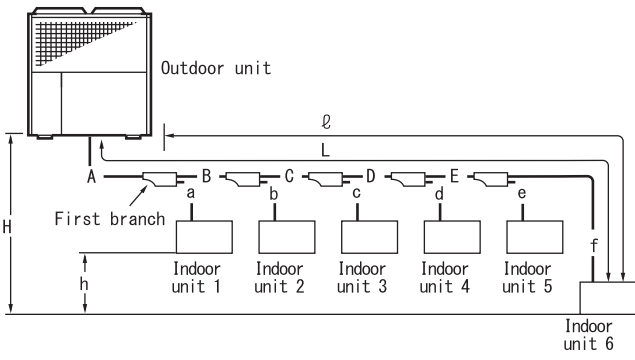
<p>Layout example (When 6 indoor units are connected)</p> 			
Permissible piping length	Maximum piping length (L)* (Equivalent length/Actual length)	$A + B + C + D + E + f$	190/165 m or less
	Maximum piping length after the first branch ( $\ell$ )	$B + C + D + E + f$	90 m or less
	Difference between maximum piping length after the first branch ( $\ell$ ) and the length of the first branch (a) (when "a" is the shortest length after the first branch)	$\ell - a$	70 m or less
Permissible height difference	Maximum height difference between indoor units and outdoor units (H)	When outdoor units are higher than indoor units	50 m or less
		When outdoor units are lower than indoor units	40 m or less
	Maximum height difference between indoor units (h)	$35 - \frac{(\ell - a)}{2}$ m or less However, $0 \leq h \leq 15$	
Branch piping	How to select the branch piping kit (line branch)		
	<ul style="list-style-type: none"> <li>• Since the size of branching pipe varies depending on the total capacity of indoor units downstream from the branch, refer to the following table to select the branch piping kit.</li> </ul>		
	Classification		Model
	First branch for outdoor unit capacity (kW)	45.0 / 56.0	KHRP26M72T
		71.0 / 85.0	KHRP26M73T
	Second branch and after for total downstream indoor unit capacity (kW)	less than 22.4	KHRP26M22T
22.4 or more and less than 33.0		KHRP26M33T	
33.0 or more and less than 71.0		KHRP26M72T	
	71.0 or more	KHRP26M73T	
Important reminder:			
<ul style="list-style-type: none"> <li>• Be sure to use the indoor unit piping and indoor branch piping that correspond to the indoor unit connection piping size.</li> <li>• Always install branch piping joints (for both vapor and liquid) so that the joint branches are either horizontally or vertically oriented. (Refer to "3-5. Notes for branch piping" on page 32.)</li> </ul>			

\* In case total connected capacity exceeds 130% of rated capacity, restrict actual length to 100m

## ◆ Header branching [Combined installation]

### Important

- If there is a height difference between the locations of indoor and outdoor units, be sure to include traps in the vapor line at intervals of no more than 10 m as illustrated.
- Re-branching after header branching is not allowed. Also, indoor units with the capacity of the P280 or greater can not be connected following the header branching.

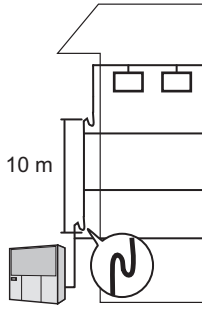
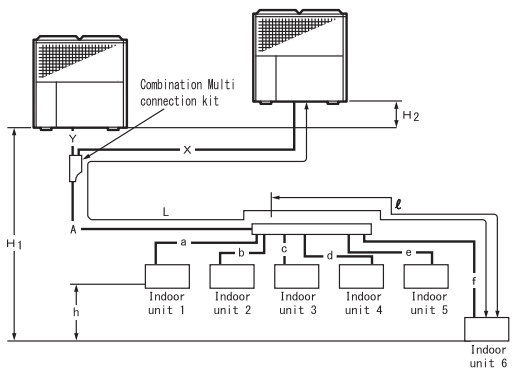
<p>Layout example (When 6 indoor units are connected)</p> <p>Note X: 10 m or less Y: 10 m or less H<sub>1</sub>: See below H<sub>2</sub>: 4 m or less</p> 															
Permissible piping length	Maximum piping length (L)* (Equivalent length/ Actual length)	$X + A + f$	190/165 m or less												
	Maximum piping length after the first branch ( $\ell$ )	f	90 m or less												
	Difference between maximum piping length after the first branch ( $\ell$ ) and the length of the first branch (a) (when "a" is the shortest length after the first branch)	$\ell - a$	70 m or less												
Permissible height difference	Maximum height difference between indoor units and outdoor units (H <sub>1</sub> )	When outdoor units are higher than indoor units	50 m or less												
		When outdoor units are lower than indoor units	40 m or less												
	Maximum height difference between indoor units (h)	$35 - \frac{(\ell - a)}{2} \text{ m or less}$ However, $0 \leq h \leq 15$													
Branch piping	Selection of Combination Multi connection kit	P710 + P850, P850 + P850	KHRP26A75T												
		Other	KHRPMULTIF												
<p>How to select the branch piping kit (header branch)</p> <ul style="list-style-type: none"> <li>• Connect crimp pipe (locally procured) to the branching points (on the indoor unit connection side) in accordance with the number of connected indoor units.</li> <li>• Refer to the header branching kit (sold separately) for the crimp pipe size.</li> </ul>															
<table border="1"> <thead> <tr> <th>Total capacity (kW) of indoor units downstream from each branch</th> <th>Header branching kit type</th> <th>Number of branches</th> </tr> </thead> <tbody> <tr> <td>Less than 22.4</td> <td>KHRP26M22H</td> <td rowspan="4">Up to 8 branches</td> </tr> <tr> <td>22.4 or more and less than 33.0</td> <td>KHRP26M33H</td> </tr> <tr> <td>33.0 or more and less than 71.0</td> <td>KHRP26M72H</td> </tr> <tr> <td>71.0 or more</td> <td>KHRP26M73H</td> </tr> </tbody> </table>				Total capacity (kW) of indoor units downstream from each branch	Header branching kit type	Number of branches	Less than 22.4	KHRP26M22H	Up to 8 branches	22.4 or more and less than 33.0	KHRP26M33H	33.0 or more and less than 71.0	KHRP26M72H	71.0 or more	KHRP26M73H
Total capacity (kW) of indoor units downstream from each branch	Header branching kit type	Number of branches													
Less than 22.4	KHRP26M22H	Up to 8 branches													
22.4 or more and less than 33.0	KHRP26M33H														
33.0 or more and less than 71.0	KHRP26M72H														
71.0 or more	KHRP26M73H														
<p>Important reminder:</p> <ul style="list-style-type: none"> <li>• Be sure to use the header branching and indoor unit piping that correspond to the indoor unit connecting piping size.</li> <li>• Always install the header branching joint (both vapor and liquid sides) so that the joint branches horizontally. (Refer to "3-5. Notes for branch piping" on page 32.)</li> </ul>															

\* In case total connected capacity exceeds 130% of rated capacity, restrict actual length to 100m

## ◆ Header branching [Stand-alone installation]

### Important

- If there is a height difference between the locations of indoor and outdoor units, be sure to include traps in the vapor line at intervals of no more than 10 m as illustrated.
- Re-branching after header branching is not allowed. Also, indoor units with the capacity of the P280 or greater can not be connected following the header branching.

Layout example  
(When 6 indoor units are connected)

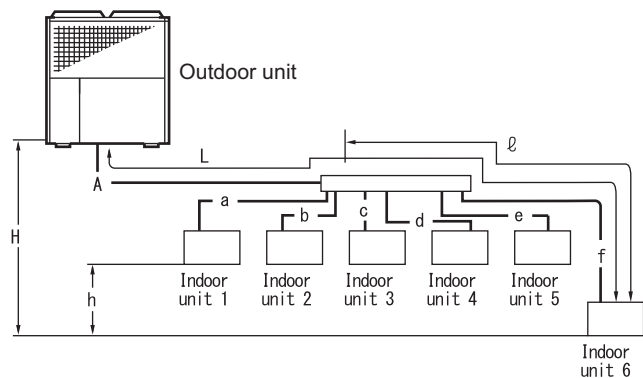
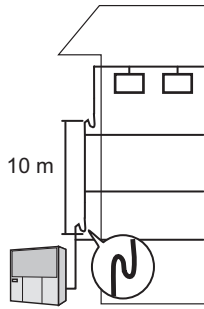

Permissible piping length	Maximum piping length (L)* (Equivalent length/Actual length)	A + f	190/165 m or less
	Maximum piping length after the first branch ( $\ell$ )	f	90 m or less
	Difference between maximum piping length after the first branch ( $\ell$ ) and the length of the first branch (a) (when "a" is the shortest length after the first branch)	$\ell - a$	70 m or less
Permissible height difference	Maximum height difference between indoor units and outdoor units (H)	When outdoor units are higher than indoor units	50 m or less
		When outdoor units are lower than indoor units	40 m or less
	Maximum height difference between indoor units (h)	$35 - \frac{(\ell - a)}{2}$ m or less However, $0 \leq h \leq 15$	

Branch piping	How to select the branch piping kit (header branch)		
	<ul style="list-style-type: none"> <li>• Connect crimp pipe (locally procured) to the branching points (on the indoor unit connection side) in accordance with the number of connected indoor units.</li> <li>• Refer to the header branching kit (sold separately) for the crimp pipe size.</li> </ul>		
	Total capacity (kW) of indoor units downstream from each branch	Header branching kit type	Number of branches
	Less than 22.4	KHRP26M22H	Up to 4 branches
	22.4 or more and less than 33.0	KHRP26M33H	Up to 8 branches
33.0 or more and less than 71.0	KHRP26M72H		
71.0 or more	KHRP26M73H		
Important reminder:			
<ul style="list-style-type: none"> <li>• Be sure to use the header branching and indoor unit piping that correspond to the indoor unit connecting piping size.</li> <li>• Always install the header branching joint (both vapor and liquid sides) so that the joint branches horizontally. (Refer to "3-5. Notes for branch piping" on page 32.)</li> </ul>			

\* In case total connected capacity exceeds 130% of rated capacity, restrict actual length to 100m

## ◆ Line - header combined branching [Combined installation]

### Important

- If there is a height difference between the locations of indoor and outdoor units, be sure to include traps in the vapor line at intervals of no more than 10 m as illustrated.
- Re-branching after header branching is not allowed. Also, indoor units with the capacity of the P280 or greater can not be connected following the header branching.

#### Layout example

(When 6 indoor units are connected)

Note X: 10 m or less  
Y: 10 m or less  
H<sub>1</sub>: See below  
H<sub>2</sub>: 4 m or less

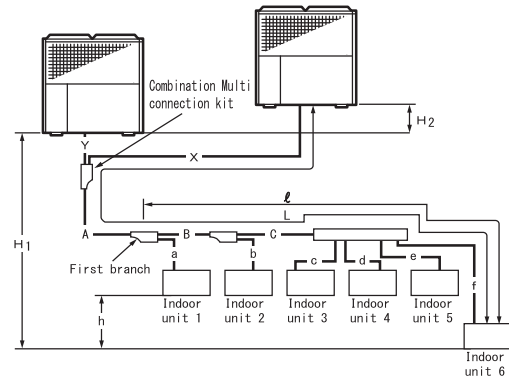
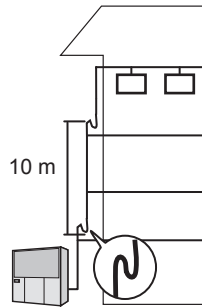

Permissible piping length	Maximum piping length (L)* (Equivalent length/Actual length)	$X + A + B + C + f$	190/165 m or less
	Maximum piping length after the first branch ( $\ell$ )	$B + C + f$	90 m or less
	Difference between maximum piping length after the first branch ( $\ell$ ) and the length of the first branch (a) (when "a" is the shortest length after the first branch)	$\ell - a$	70 m or less
Permissible height difference	Maximum height difference between indoor units and outdoor units (H <sub>1</sub> )	When outdoor units are higher than indoor units	50 m or less
		When outdoor units are lower than indoor units	40 m or less
	Maximum height difference between indoor units (h)	$35 - \frac{(\ell - a)}{2}$ m or less However, $0 \leq h \leq 15$	

Branch piping	Selection of Combination Multi connection kit	P710 + P850, P850 + P850	KHRP26A75T	
		Other	KHRPMULTIF	
	How to select the branch piping kit (line branch) Since the size of branching pipe varies depending on the total capacity of indoor units downstream from the branch, refer to the following table to select the branch piping kit.			
	Classification			
	First branch for outdoor unit capacity (kW)	90.0 to 142	KHRP26M73T	
		156 to 170	KHRP26M75T	
	Second branch and after for total downstream indoor unit capacity (kW)	Less than 22.4	KHRP26M22T	
		22.4 or more and less than 33.0	KHRP26M33T	
		33.0 or more and less than 71.0	KHRP26M72T	
		71.0 or more	KHRP26M73T	
Important reminder:				
<ul style="list-style-type: none"> <li>• Be sure to use the indoor unit piping and indoor branch piping that correspond to the indoor unit connecting piping size.</li> <li>• Always install branch piping joints (for both vapor and liquid) so that the joint branches are either horizontally or vertically oriented.</li> </ul>				
How to select the branch piping kit (header branch)				
<ul style="list-style-type: none"> <li>• Connect crimp pipe (locally procured) to the branching points (on the indoor unit connection side) in accordance with the number of connected indoor units.</li> <li>• Refer to the header branching kit (sold separately) for the crimp pipe size.</li> </ul>				
Total capacity (kW) of indoor units downstream from each branch		Header branching kit type	Number of branches	
Less than 22.4		KHRP26M22H	Up to 8 branches	
22.4 or more and less than 33.0		KHRP26M33H		
33.0 or more and less than 71.0		KHRP26M72H		
71.0 or more		KHRP26M73H		
Important reminder:				
<ul style="list-style-type: none"> <li>• Be sure to use the header branching and indoor unit piping that correspond to the indoor unit connecting piping size.</li> <li>• Always install the header branching joint (both vapor and liquid sides) so that the joint branches horizontally. (Refer to "3-5. Notes for branch piping" on page 32.)</li> </ul>				

\* In case total connected capacity exceeds 130% of rated capacity, restrict actual length to 100m

## ◆ Line - header combined branching [Stand-alone installation]

### Important

- If there is a height difference between the locations of indoor and outdoor units, be sure to include traps in the vapor line at intervals of no more than 10 m as illustrated.
- Re-branching after header branching is not allowed. Also, indoor units with the capacity of the P280 or greater can not be connected following the header branching.

Layout example  
(When 6 indoor units are connected)

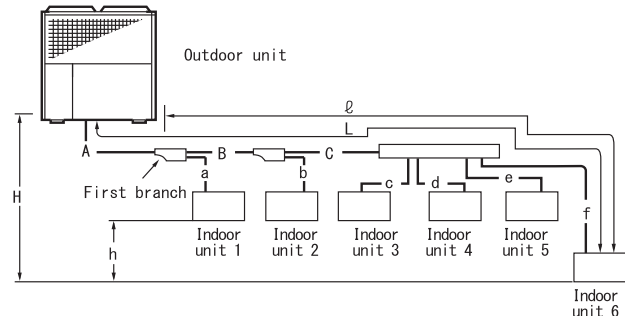
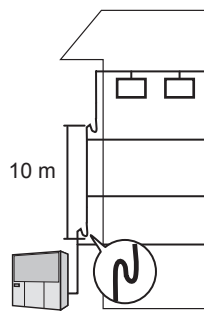

Permissible piping length	Maximum piping length (L)* (Equivalent length/Actual length)	$A + B + C + f$	190/165 m or less
	Maximum piping length after the first branch ( $\ell$ )	$B + C + f$	90 m or less
	Difference between maximum piping length after the first branch ( $\ell$ ) and the length of the first branch (a) (when "a" is the shortest length after the first branch)	$\ell - a$	70 m or less
Permissible height difference	Maximum height difference between indoor units and outdoor units (H)	When outdoor units are higher than indoor units	50 m or less
		When outdoor units are lower than indoor units	40 m or less
	Maximum height difference between indoor units (h)	$35 - \frac{(\ell - a)}{2}$ m or less However, $0 \leq h \leq 15$	

How to select the branch piping kit (line branch)

- Since the size of branching pipe varies depending on the total capacity of indoor units downstream from the branch, refer to the following table to select the branch piping kit.

	Classification	Model
First branch for outdoor unit capacity (kW)	45.0 / 56.0	KHRP26M72T
	71.0 / 85.0	KHRP26M73T
Second branch and after for total downstream indoor unit capacity (kW)	Less than 22.4	KHRP26M22T
	22.4 or more and less than 33.0	KHRP26M33T
	33.0 or more and less than 71.0	KHRP26M72T
	71.0 or more	KHRP26M73T

Important reminder:

- Be sure to use the indoor unit piping and indoor branch piping that correspond to the indoor unit connecting piping size.
- Always install branch piping joints (for both vapor and liquid) so that the joint branches are either horizontally or vertically oriented.

Branch piping

How to select the branch piping kit (header branch)

- Connect crimp pipe (locally procured) to the branching points (on the indoor unit connection side) in accordance with the number of connected indoor units.
- Refer to the header branching kit (sold separately) for the crimp pipe size.

Total capacity (kW) of indoor units downstream from each branch	Header branching kit type	Number of branches
Less than 22.4	KHRP26M22H	Up to 8 branches
22.4 or more and less than 33.0	KHRP26M33H	
33.0 or more and less than 71.0	KHRP26M72H	
71.0 or more	KHRP26M73H	

Important reminder:

- Be sure to use the header branching and indoor unit piping that correspond to the indoor unit connecting piping size.
- Always install the header branching joint (both vapor and liquid sides) so that the joint branches horizontally. (Refer to "3-5. Notes for branch piping" on page 32.)

\* In case total connected capacity exceeds 130% of rated capacity, restrict actual length to 100m

## ◆ AWS connection

### Important

- If there is a height difference between the locations of indoor and outdoor units, be sure to include traps in the vapor line at intervals of no more than 10 m as illustrated.

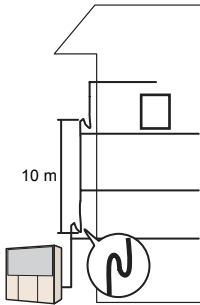
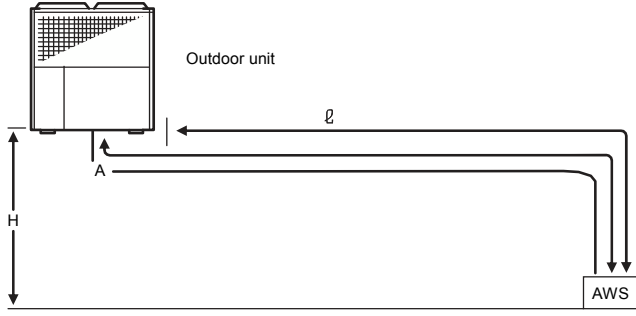
<p>Layout example (When AWS is connected)</p> <p>Note: If there is a height difference between the location of AWS and outdoor units, apply a small "trap pipes" only on the vapor line at least every 10 m as illustrated.</p> 			
Permissible piping length	Maximum piping length (L) (Equivalent length/ Actual length)	$L = A$	70/60 m or less
Permissible height difference	Height difference between AWS unit and outdoor unit (H)	When outdoor unit is higher than indoor unit	25 m or less
		When outdoor unit is lower than indoor unit	20 m or less

### Warning



- Always refer to AWS installation manual for maintenance clearance and position of the unit.
- Always connect the AWS to the designed outdoor unit for AWS.
- Never exceed the maximum allowed distance between AWS and GHP. Failure in doing so can result in malfunctioning of the units and invalidates the warranty.

### 3-4. Precautions during installation of refrigerant piping

#### 1) Precautions against refrigerant leakage

**Warning**

■ **Make sure that refrigerant never exceeds the potential concentration limit in the room even if the refrigerant vapor leaks inside the room.**  
 Refrigeration gas concentration in excess of the room concentration limit could result in accidents due to lack of oxygen. The refrigerant concentration as calculated below must not exceed the concentration limit.

$$\frac{\text{Total amount of refrigerant in the refrigerant equipment (kg)}}{\text{Minimum indoor volume of the room in which the indoor unit is installed (m}^3\text{)}} \leq \text{Concentration limit (kg/m}^3\text{)}$$

If the calculated concentration exceeds the concentration limit, either an opening must be made to bring the calculated concentration below the limit, or a mechanical ventilation system linked to a gas leakage detector must be provided.

■ **Be sure to check for refrigerant gas leakage.**  
 Although the refrigerant is non-flammable, non-toxic and odorless fluorocarbon, in the event of fluorocarbon leakage, toxic gas may be produced from contact with fire. Moreover, since the specific gravity of fluorocarbon is greater than that of air, gas covering the floor surface could cause an accident due to lack of oxygen.

- The concentration limit is the threshold at which emergency procedures can be performed without affecting the human body when refrigerant has leaked into the air.  
**Concentration limit: 0.3 kg/m<sup>3</sup>**
- At the time of shipping, the outdoor unit has already been charged with refrigerant as indicated below. To calculate the total amount of refrigerant, add the amount of refrigerant charge added at the installation site to the amount charged at factory.

Outdoor unit	Refrigerant type	Charged amount of refrigerant (at the time of shipping) (kg)	GWP	CO <sub>2</sub> equivalent (ton)
P450	R410A	11.5	2088	24.012
P560				
P710				
P850				

- A reference for the minimum room volume and floor area in relation to the refrigerant amount is shown in the graph at right. If the calculated concentration exceeds the concentration limit, be sure to take either of the following countermeasures.

**Countermeasure 1:**



Provide an opening whose area is 0.15 % or more of the floor area at the bottom of each door. Or, provide an opening other than a door.

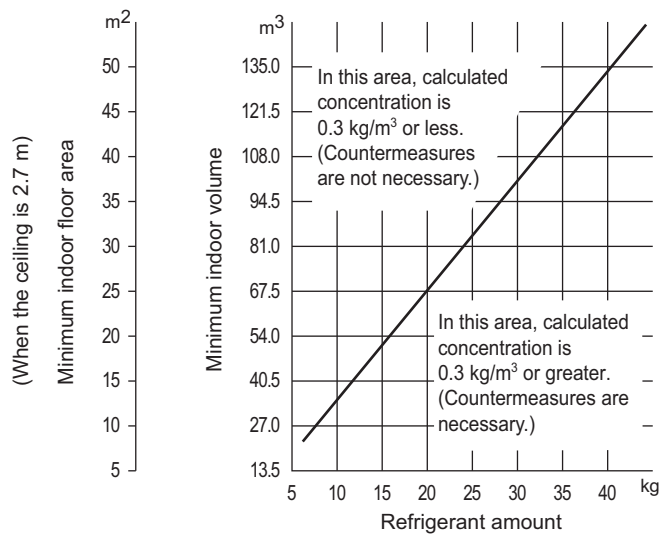

**Countermeasure 2:**

Provide a mechanical ventilation system linked to a gas leakage detection device.



## 2) General precautions

 <b>Warning</b>	
	<ul style="list-style-type: none"><li>■ <b>This equipment uses exclusively R410A non-flammable refrigerant. Never charge with other refrigerant, air, oxygen, propane, or other materials.</b> Doing so could result in an explosion or fire.</li></ul>
	<ul style="list-style-type: none"><li>■ <b>Be sure to remove any flammable materials before brazing.</b> Failure to do so could result in fire.</li><li>■ <b>Be sure to use non-flammable and non-toxic cleaning liquid for washing.</b> Use of flammable cleaning liquid could result in an explosion or fire.</li><li>■ <b>Be sure to provide adequate ventilation when installing the refrigerant piping, as installation in a tightly closed space could result in an accident due to lack of oxygen.</b> If cleaning fluid comes in contact with fire, toxic gasses can result.</li></ul>

 <b>Caution</b>	
	<ul style="list-style-type: none"><li>■ <b>Be sure to collect the cleaning liquid after washing.</b> Indiscriminate chlorofluorocarbon (CFC) emission into the atmosphere is prohibited by law. Dispose of refrigerant as required by relevant local and national regulations.</li></ul>

### Important reminder

- The R410A specification requires stringent control of impurities, such as moisture and foreign material. The following precautions must be strictly observed during installation in order to prevent damage to the equipment.
- During brazing, always flow nitrogen gas through the piping. Brazing in the absence of nitrogen gas will produce oxide film, leading to equipment breakdown.
- Do not use any antioxidant sold on the market. It may have an adverse effect on the refrigerant and refrigerant oil, resulting in equipment breakdown.

### ■ Refrigerant piping installation

- During installation of piping, always close off the ends of the piping with tape or caps to prevent entry of moisture, dust or other.
- Always thoroughly flush the inside of the piping with nitrogen gas to remove foreign object, moisture and other impurities.
- Always use a pipe cutter to cut pipe.
- The inner edges of cuts will have burrs. Always remove these burrs before flare processing.
- To ensure a smooth flow of nitrogen gas, open the solenoid valve or expansion valve in the downstream side and the piping unit, and drain air in the pipe.
- In order to prevent oxide film from forming inside piping during brazing, always braise with nitrogen gas flowing through the piping with a pressure reduction valve. The appropriate nitrogen gas pressure is 0.02 MPa. (You feel a breeze on your cheek at this pressure.)



- When flowing nitrogen gas through the piping during brazing, ensure that the end of the pipe that the nitrogen is flowing into is sealed to prevent entry of air.

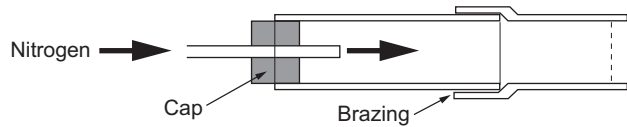

- Conduct pipe brazing while cooling to prevent peripheral parts such as the stop valve from being overheated. Otherwise, it causes a failure.
- Route the refrigerant piping so as to reserve a space for servicing.

## ■ Sealing test and vacuuming

- In order to prevent mixing of other refrigerant or refrigerant oil, be sure to use a gauge manifold, charging hose and vacuum pump that are exclusively for R410A.
- Be sure to perform a sealing test. If R410A leaks, there is a possibility that the composition of the refrigerant inside the equipment will change. In the event of a leak, the refrigerant must be recovered and then the system must be recharged. Do not perform replenishment charging. (See “3-7. 1) Refrigerant vapor leakage test” on page 34.)
- Since systems with R410A are much more susceptible to damage from moisture than systems with the previous type of refrigerant, always perform a thorough vacuuming (drying) to prevent equipment breakdown. (See “3-7. 2) Vacuuming with a vacuum pump” on page 36.)

## ■ Charging refrigerant

- Never charge R410A as a vapor. Always charge it as a liquid. Adding refrigerant in the vapor state may cause a compositional change in the refrigerant, and could result in performance degradation or a breakdown.

## ■ Notes on pipe end flaring

The R410A flare dimensions differ from those used previously with R407C. We recommend using the R410A flaring tool, but if protrusion amount B can be adjusted with the protrusion adjusting gauge, the old tool can be used.

Pipe end flare: A (mm)

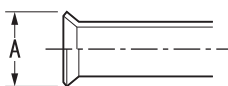

Copper pipe outer diameter	A
	0 - 0.4
ø6.4	9.1
ø9.5	13.2
ø12.7	16.6
ø15.9	19.7
ø19.1	24.0

Amount of copper pipe protrusion for flaring: B (mm)

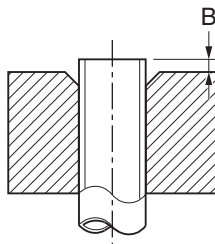

Copper pipe outer diameter	In the case of rigid (clutch)	
	When using the R410A tool	When using the old tool
ø6.4	0 to 0.5	0.7 to 1.3
ø9.5		
ø12.7		
ø15.9		
ø19.1		

## ■ Precautions when connecting flare nuts

### Warning



#### ■ Tighten flare nuts using an open-end wrench and a torque wrench to verify that the tightening torque is correct.

If the torque is not correct, broken or loose joints may cause refrigerant to leak, possibly leading to an accident due to lack of oxygen.

#### Flare nut tightening torque

Outer diameter (mm)	Nominal diameter (inch)	Flare tightening torque (N.m)
6.4	1/4	14 to 18
9.5	3/8	34 to 42
12.7	1/2	49 to 61
15.9	5/8	68 to 82
19.1	3/4	100 to 120

- If you have no choice but to tighten the flare nut without a torque wrench, tighten until you encounter resistance, and then continue tightening by no more than the angle indicated below.

#### Tightening angle

Pipe diameter	Tightening angle
ø6.4, ø9.5	60° to 90°
ø12.7, ø15.9, ø19.1	30° to 60°

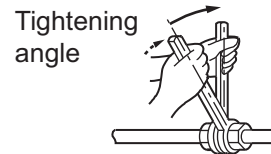

- Apply refrigerant oil lightly to the inner face of the pipe flare before tightening the flare nut.

## ■ Others

- Refrigerant oil absorbs moisture from the air.  
The following notes must be observed when refrigerant oil replenishment is required during service.
  - Perform charging operation as quickly as possible.
  - Open the container lid immediately before use.
  - Discard any oil remaining after use.
  - Keep the lid of the container tightly closed when temporarily storing refrigerant oil during the charging process.
- Treatment of refrigerant pipe for storage  
(Treatment method)  
Be sure to treat the end of piping to prevent contamination with moisture, dirt, and dust. Failure to do so may result in serious problems.

Storage location of refrigerant piping	Storage period	Pipe end treatment method
Outdoor	1 month or more	Pinching
	Less than 1 month	Pinching or Taping
Indoor	-	Pinching or Taping

(Treatment Method)

#### ① Pinching

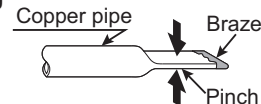

#### ② Taping

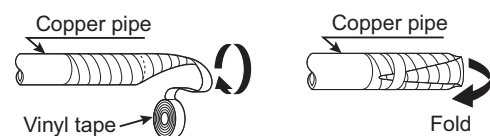

### 3-5. Notes for branch piping

**Important reminder**

- When installing the branch pipe kit, do not bend the main pipe near the connection. If such bending is unavoidable, make a minimum of 150 mm of straight portion. However, do not use a bent pipe with an external diameter of  $\varnothing 28.6$  or larger.

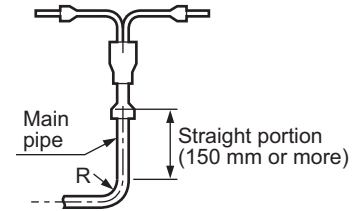

- Do not perform another branching after the header branching.
- When making header branch connections, connect crimp pipe (locally procured) in accordance with the number of indoor units connected.
- Always install line branch pipes (both vapor and liquid) so that the branch lines are arrayed either horizontally or vertically.

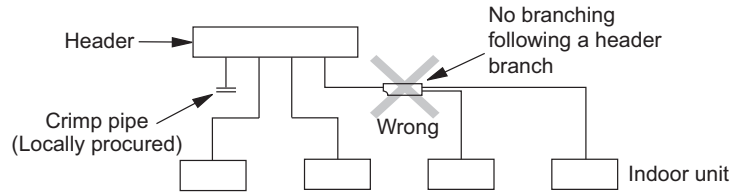

Horizontal			Vertical	
Correct	Wrong	Wrong	Correct	Correct

- Always install header branch pipes (both vapor and liquid) so that the branch lines are arrayed horizontally.

	Horizontal		
Vapor line			
Liquid line			

### 3-6. Stop valve connections and opening/closing stop valves

#### 1) Stop valve connections

- Both liquid and vapor lines connections must be brazed.

##### Important reminder

- Connect refrigerant piping with the stop valves on the outdoor unit fully closed (factory default). Do not operate the stop valves until all the refrigerant piping for the indoor and outdoor units has been connected, and the refrigerant leakage test, vacuuming operation and refrigerant replenishment charging have been completed. Note that both the vapor and the liquid line valves must be fully open in operating.
- When brazing refrigerant piping to the stop valves, be sure not to damage the power supply wiring, communication wire, the condensation drain port, or the exhaust condensate drain hose with brazing flame.

#### 2) Opening and closing the stop valves (Perform this operation after the refrigerant leakage test, vacuuming operation, and additional refrigerant charging have been completed.)

##### Caution



- When opening or closing the cap using an open-end wrench, wear a protector such as gloves. Otherwise, it may cause a hand injury.

- Open the liquid line stop valve first, and then open the vapor line stop valve.
1. Remove the cap.
  2. Turn the valve shaft by 90° counterclockwise using an open-end wrench. The valve is fully opened at the position where the pin hits the stopper.
  3. Attach the stopper ring supplied with this product to both the liquid line and vapor lines. (Refer to the figure on the right.)
  4. Firmly tighten the cap to the appropriate tightening level as indicated below.

<Liquid/gas>

Fully closed  
(Factory default)

Fully open

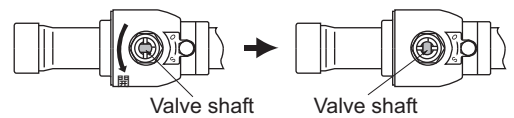

Right-hand figure

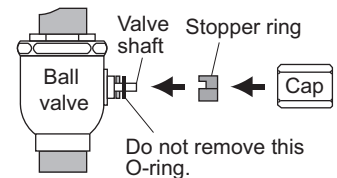

Liquid line	26 to 32 N·m
Vapor line	

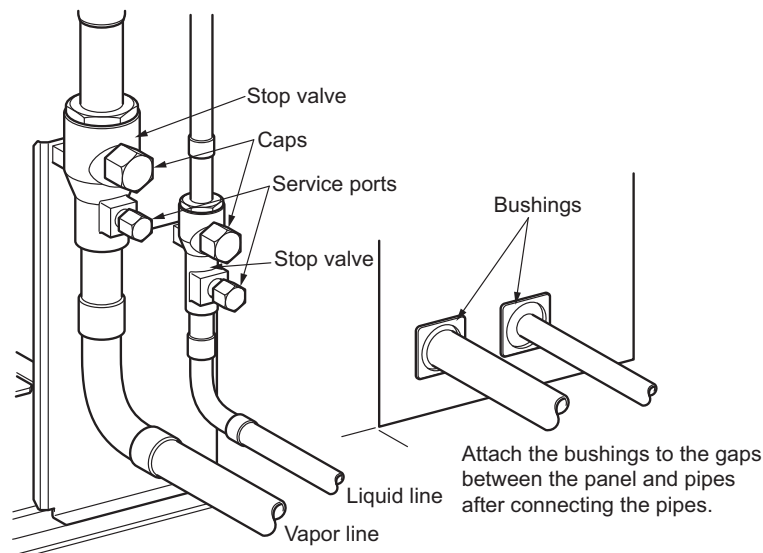

#### Important reminder

- Connect to the on-site connection pipe by brazing.  
(To perform brazing, always pass nitrogen gas from the service port.)
- To ensure a smooth flow of nitrogen gas, open the solenoid valve or expansion valve in the downstream side and the piping unit, and drain air in the pipe.
- Conduct pipe brazing while cooling to prevent the stop valves from being overheated. Otherwise, it causes a failure.



### 3-7. Refrigerant vapor leakage test and vacuuming

#### 1) Refrigerant vapor leakage test

#### Warning



- After the refrigerant piping has been installed, always perform a sealing test to confirm that no refrigerant vapor is leaking.

If refrigerant leaks and refrigerant vapor exceeds the limit concentration, it could cause an accident due to lack of oxygen.

#### Important reminder

- Carefully pressurize nitrogen gas so that the leakage test pressure value does not exceed the specified value.  
A rapid pressurization causes a damage of the refrigerant piping or a failure in the equipment.

1. Remove the service port caps of the stop valves. Connect the gauge manifold as shown in the illustration below. Open V1, V2 and V3 and pressurize with nitrogen gas.
  - Keep the stop valves closed. Always pressurize both the liquid and the vapor systems.
  - The leakage test pressure is  $3.8^{+0.1}_0$  MPa.
2. Gradually increase the pressure to the specified pressure. Do not increase the pressure abruptly.
  - a) Once 0.5 MPa is applied, hold the pressure and let it stand for 5 minutes or more. Check that there is no pressure drop.
  - b) Next, increase the pressure to 1.5 MPa and again let it stand for 5 minutes or more. Confirm that the pressure does not drop.
  - c) After that, increase the pressure to the specified value (3.8 MPa) and note the ambient temperature and pressure.
  - d) Let it stand at the specified pressure for one day. If there is no pressure drop, the system is OK. If ambient temperature changes by 1°C, the pressure changes 0.01 MPa accordingly. Judge if there is refrigerant leakage taking account of temperature change between the beginning and end of the leakage test.
  - e) If a drop in pressure is detected through steps a-d, there is a leakage. Apply soapy solution to the welded sections and flare joints to determine the leaking locations and then fix them. Perform the leakage test again once the leaks have been fixed.

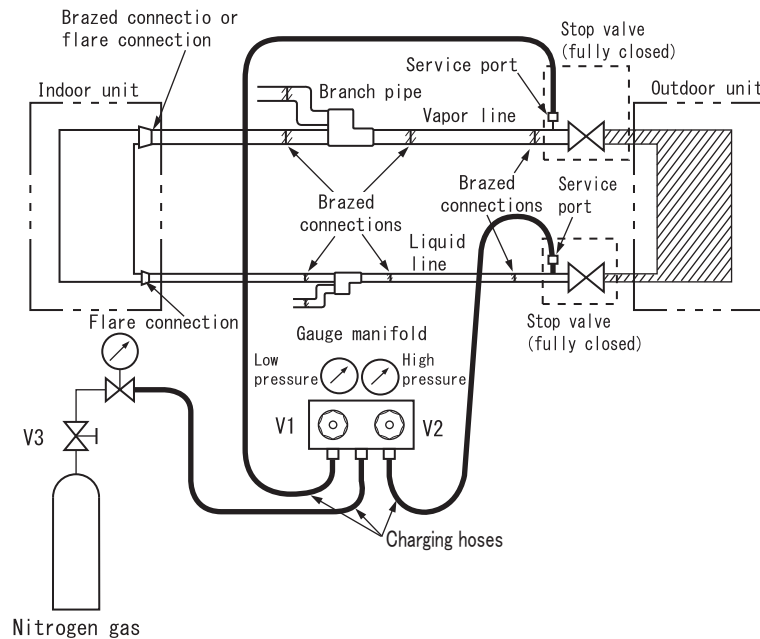

## 2) Vacuuming with a vacuum pump

### Important reminder

- Be sure to perform vacuuming using a vacuum gauge.
- Vacuuming must be performed with the stop valves on the outdoor unit in the fully closed position.
- Do not perform an air purge with refrigerant inside the outdoor unit or the refrigerant tank.
- Use a vacuum pump that is able to attain pressure lower than  $-101$  kPa ( $-755$  mmHg).
- When the pressure reaches  $-101$  kPa ( $-755$  mmHg) after vacuuming has started, continue vacuuming for 2 or more hours.

Apply vacuum at the both service ports of the liquid and the vapor line stop valves.

### <Operation Flow>

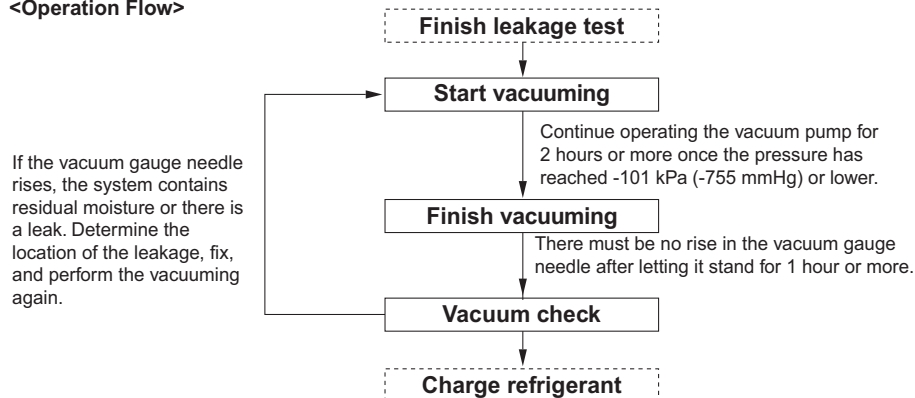

[When there is a possibility of residual moisture in piping]

Apply this operation when rainy weather such as that in the rainy season lengthens the construction period, which may cause dew to form in refrigerant piping, or when rainwater enters the piping or unit. In this case, follow the steps below to take the appropriate action. Be sure to cure the edges of the refrigerant piping if not performed.

- ① Increase the pressure to  $0.05$  MPa with nitrogen gas after vacuuming for 2 hours or more.
- ② Then, perform vacuuming again for 1 hour or more and make sure the pressure has dropped to  $-101$  kPa.
- ③ If the pressure does not drop to  $-101$  kPa after 2 hours of vacuuming, repeat steps ① and ② until the pressure drops to  $-101$  kPa.
- ④ After the pressure has dropped to  $-101$  kPa or lower, let stand for 1 hour and make sure that the pressure indication on the vacuum gauge does not rise.

(Note) Since this unit uses exclusively R410A refrigerant, keep the following points in mind.

- To avoid cross-contamination with other types of oil, make sure to separate maintenance tools according to the type of refrigerant used. In particular, never use the same gauge manifold and the charging hose with other refrigerants (R22, R407C etc.).
- Use a backflow prevention adapter to prevent vacuum pump oil from entering the refrigeration system.

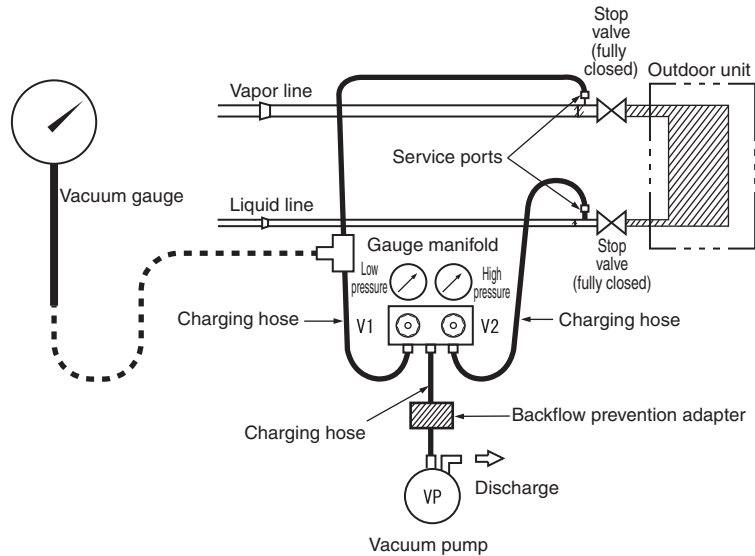

### Important

- If water remains in the refrigerant piping, it causes a failure in the equipment.

### 3-8. Charging the refrigerant

#### Important reminder

When charging, accurately measure the length of the piping and charge with the proper amount of refrigerant. If the amount of refrigerant is not correct, performance will decline or a breakdown could occur.

After completion of charging, complete the installation record on the "POINTS FOR INSTALLATION" plate inside the outdoor unit control box panel. Also, calculate the refrigerant amount for the whole system and write down the amount on the plate. The calculation formula is shown on the plate. (Write with an oil-based marker so that the record does not quickly fade.)

#### 1) Refrigerant charging amount DX systems

Follow the formula below to calculate the amount of refrigerant required for charging depending on the liquid piping length for each size of the refrigerant piping.

$$\text{Charge amount (kg)} = [l_1 \times 0.353] + [l_2 \times 0.250] + [l_3 \times 0.170] + [l_4 \times 0.110] + [l_5 \times 0.054] + [l_6 \times 0.022] + \alpha (*1)$$

$l_1$ : Liquid piping  $\varnothing$ 22.2 total length (m)

$l_4$ : Liquid piping  $\varnothing$ 12.7 total length (m)

$l_2$ : Liquid piping  $\varnothing$ 19.1 total length (m)

$l_5$ : Liquid piping  $\varnothing$ 9.5 total length (m)

$l_3$ : Liquid piping  $\varnothing$ 15.9 total length (m)

$l_6$ : Liquid piping  $\varnothing$ 6.4 total length (m)

Total number of indoor units connected to the same refrigerant system	$\alpha (*1)$				
	Stand-alone installation		Combined installation		
	Other than P850	P850	Other than P850 in both sides	P850 only in either side	P850 in both sides
1 unit	4.5	7	9	11.5	14
2 units or more	5.5	8	11	13.5	16
AHU	Refer to the AHU technical specifications for the proper extra charge				

#### 2) Refrigerant charging amount AWS systems

Follow the formula below to calculate the amount of refrigerant required for charging depending on the liquid piping length for each size of the refrigerant piping.

$$\text{Charge amount (kg)} = [l_1 \times 0.353] + [l_2 \times 0.250] + [l_3 \times 0.170] + \alpha (*2)$$

$l_1$ : Liquid piping  $\varnothing$ 22.2 total length (m)

$l_1$

$l_2$ : Liquid piping  $\varnothing$ 19.1 total length (m)

$l_2$

$l_3$ : Liquid piping  $\varnothing$ 15.9 total length (m)

$l_3$

Total number of indoor units connected	$\alpha (*2)$	
	Stand-alone installation	
	Other than P850	P850
AWS	1.5	2



### 3) Refrigerant charging method

#### **Caution**



- **When charging, be sure to wear a pair of leather gloves.**  
If the refrigerant touches your skin directly, it may cause frostbite.

#### **Important reminder**

- **Always charge with refrigerant in the liquid phase. Charging with refrigerant in the vapor phase may cause composition of the refrigerant to change, and could result in a reduced performance or a breakdown.**
- **Always use a refrigerant scale when charging. Using a charging cylinder may cause composition of the refrigerant to change, and could result in a reduced performance or a breakdown.**
- **To avoid cross-contamination with other oil types, make sure to separate maintenance tools according to the type of refrigerant used. In particular, never use the gauge manifold and the charge hose with other refrigerants (R22, R407C etc.).**

1. Place the tank (with the siphon pipe attached) on the refrigerant scale.
2. Remove the charging hose from the vacuum pump and connect it to the tank.
3. Perform an air purge of the inside of the charging hose from the tank to the gauge manifold.
4. Open valves V2 and V3 and charge with the required amount of refrigerant in the liquid phase. After charging is completed, close valves V2 and V3.4

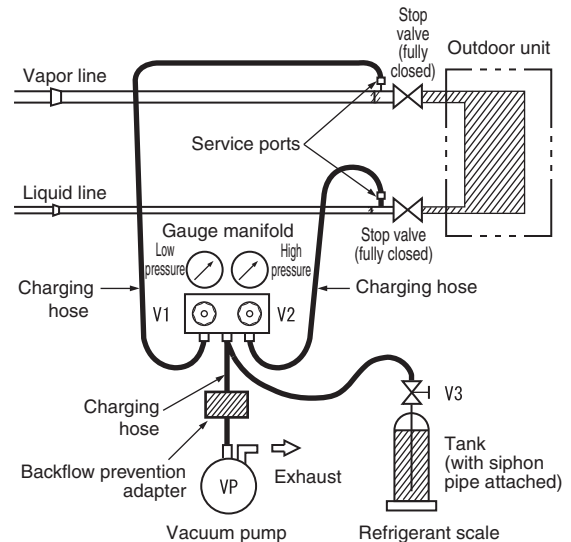

### 4) Operating the stop valve

After the refrigerant leakage test, vacuuming operation, and additional refrigerant charging have been completed, open the liquid line stop valve first, then open the vapor line stop valve. (Refer to “3-6. Stop valve connections and opening/closing stop valves” on page 33.)

#### **Important**

- **Do not refill the unit when heating mode is selected. Always select cooling mode.**

### 3-9. Refrigerant piping insulation and heat retention

#### Caution



■ Vapor and liquid line elements of the refrigerant and drain piping must be separately insulated by application of insulating material (polyethylene foam, glass wool, etc.) with a thickness of at least 10 mm. Where the dew point may exceed 30°C or the relative humidity 65%, use thicker insulating material than above.

Insufficient insulation could cause household goods to get wet due to condensation.

- Prevent heat transfer by applying insulating material separately to vapor and liquid piping, and cover up to the brazing part with insulating materials.

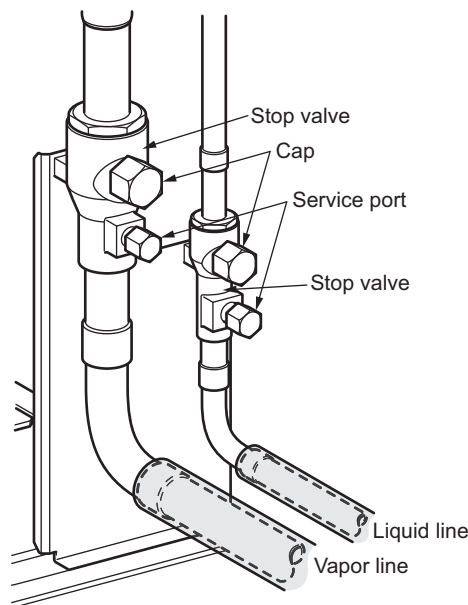

- Use insulating material with a heat resistance of 120°C or more. After completion of the refrigerant gas leakage test, use dressing tape to wrap the insulation.

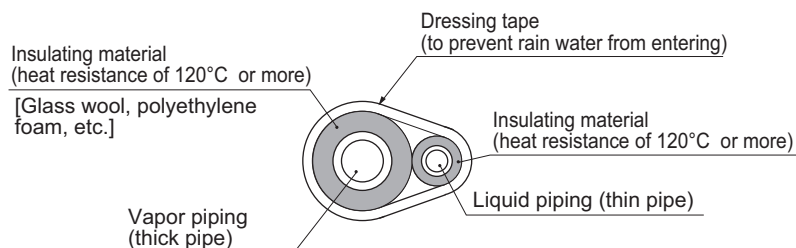

- Considerations to facilitate the inspection after piping has been performed
  1. Conduct the heat insulation work after the airtight test so that leakages can be detected when the airtight test is carried out.
  2. If a piping joint is mounted in the underground piping, provide an access hole to enable the operator to inspect the connected parts.
  3. Also be sure to provide an access hole when the piping part is mounted in the ceiling.
  4. Perform waterproofing measures for insulating materials.

### 3-10. How to secure refrigerant piping

- If the antivibration mount is used, the distance to the first refrigerant pipe fixing point must be at least  $L = 1.5 \text{ m}$ .

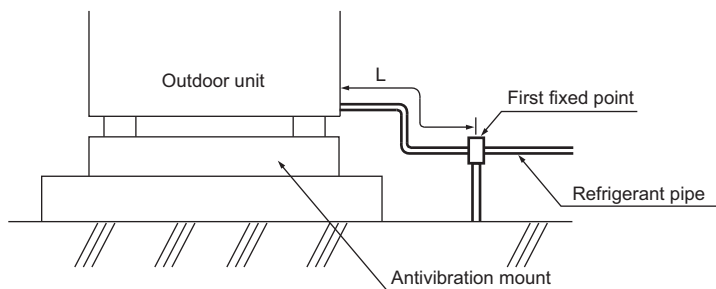

#### ■ Working example of the first fixed point in combined installation

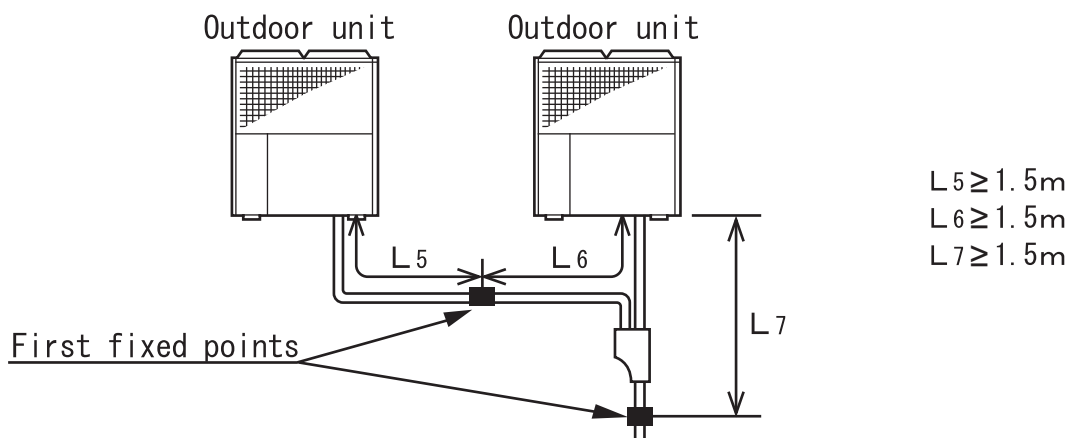
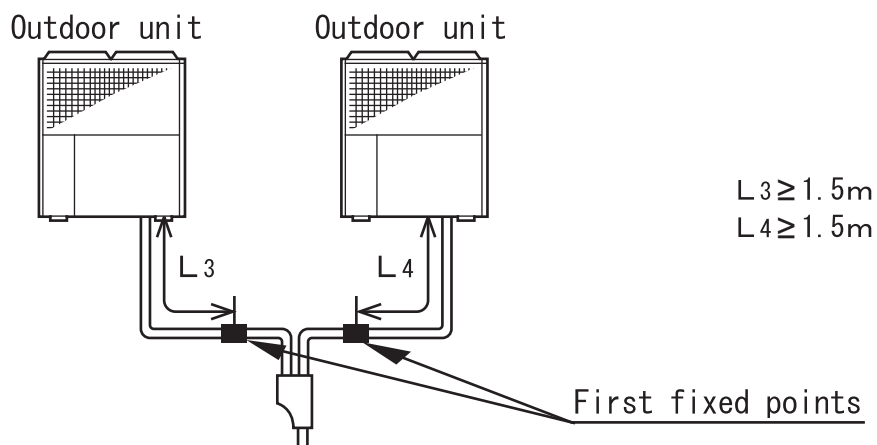
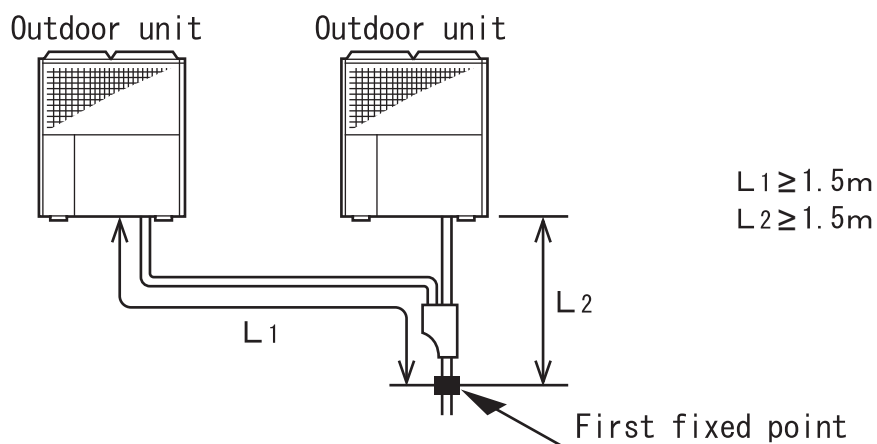

## 4. Fuel Gas Piping Installation

### Warning



- **Use only the fuel gas indicated on the name plate.**  
Using wrong type of fuel gas could cause incomplete combustion or could damage the outdoor unit.
- **Always perform a gas leakage test after connecting the piping.**  
If gas leaks, a fire or an explosion could occur.
- **Use soapy water or a gas leakage detector to check for gas leakage.**  
Using a flame reaction test could cause a fire or explosion.
- **Always use reinforced gas hose between the gas valve on the fuel gas line and the outdoor unit.**  
Failure to do so could result in gas leakage.
- **Install piping so that the fuel gas pressure at the inlet port of the outdoor unit is equal to the pressure required by the gas supply standard defined by the gas supplier.**  
Incorrect pressure of fuel gas could cause incomplete combustion or malfunction of the unit.

### Important reminder

- **Do not apply pressure in excess of 4.2 kPa when testing the fuel gas line for leakage. Doing so could damage the regulator inside the unit.**

- Gas piping for the outdoor unit must be installed as shown below.
- A gas valve (1 in the drawing below) is mandatory. This device is for servicing the fuel system.
- A pressure check tap and strainer (2 and 3 in the drawing) should be installed as necessary. These devices are for checking the supplied gas pressure and filtering the gas.

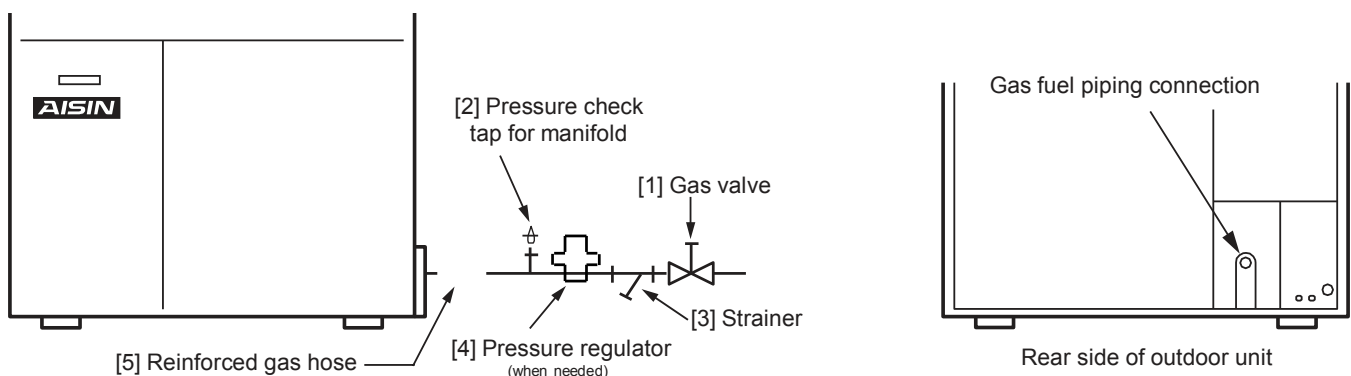

Gas type	Supply Pressure mbar [kPa]	Allowed range mbar [kPa]
G20	20 [2,0]	10 – 25 [1,0 – 2,5]
G25 – G25.3	25 [2,5]*	15 – 28 [1,5 – 2,8]
G30 – G31	30 [3,0]*	28 – 37 [2,8 – 3,7]

\* External pressure regulator included with dedicated spec.

## 5. Drain Pipe Installation

### 1) Exhaust condensate drain piping installation

#### Warning



- **Never use shared piping to drain exhaust condensate from the outdoor unit and condensation from indoor units.**

Backflow of exhaust gas into the building could cause gas poisoning or an accident due to lack of oxygen.



- **Arrange the piping so that the exhaust gas in the exhaust condensate drain is released to the atmosphere in the following cases:**

a) The exhaust condensate drain hose of the outdoor unit runs into a covered catch basin or ditch.

b) Exhaust condensate from the outdoor unit drains into the same location as drain water from the indoor unit.

If the exhaust gas is not released into the atmosphere, gas poisoning or an accident due to lack of oxygen could occur.

#### Caution



- **When installing the outdoor unit on a roof, route the exhaust condensate drain for the outdoor unit to the appropriate drainage destination.**

If drain is directly exhausted, it causes a dirt on the concrete surface or a damage of the waterproof coating.

#### Important reminder

- Exhaust gas condensate emerging from the outdoor unit drain hoses must be conveyed to an appropriate discharge point by means of a drain pipe that is installed appropriately as shown on the following page.
- Make sure that the drain pipe has an appropriate downward gradient. Otherwise, exhaust condensate will accumulate in the piping and damage the unit.
- Be careful to avoid blocking the discharge end of the exhaust condensate drain hose when inserting the hose into the exhaust condensate drain pipe. Otherwise, exhaust condensate will accumulate in the hose and damage the unit.
- When using the same pipe to drain exhaust condensate from multiple outdoor units, provide openings (breathers) upstream from the drain hose inserting points to prevent back pressure buildup.

- Condensation water from the exhaust gas comes out of the exhaust water drain hose of the outdoor unit. Connect the exhaust water drain hose to the drain piping as below.

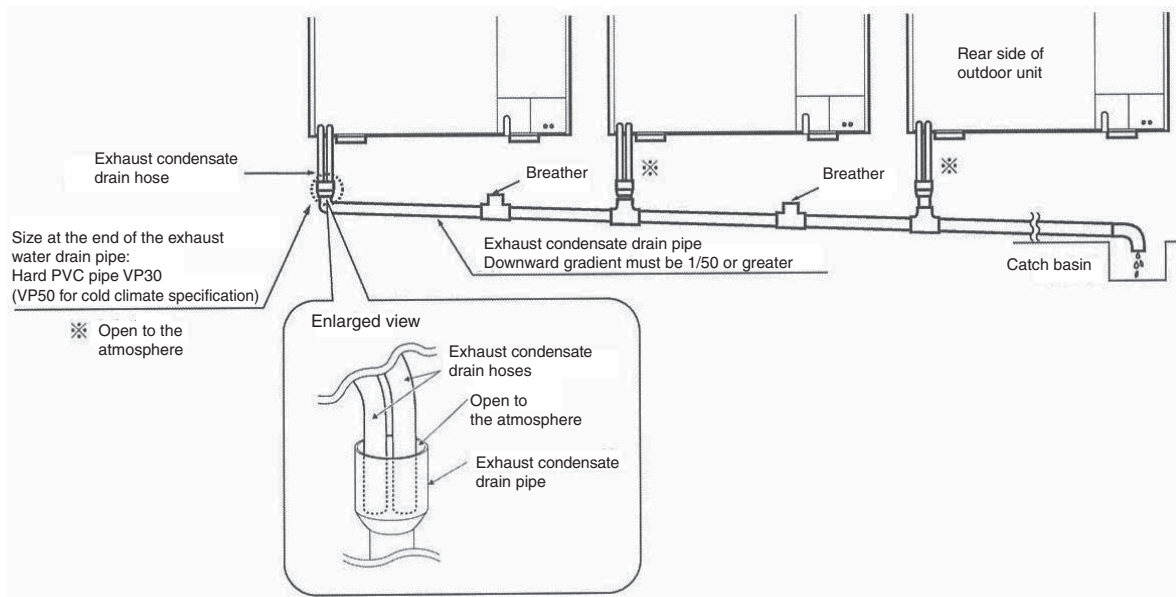

**Important reminder regarding use in cold climates**

**[Installation]**

- To prevent ice from accumulating in drain pipes, take measures to prevent exhaust condensate from freezing in climates where the outdoor air temperature can fall below 0°C. Ice blockage will damage the unit.
- **When applying insulation or heating tape to the drain pipe, be sure to leave the drain hose receptacle exposed. (Units with cold climate specification or option.)** Otherwise, the portion will overheat and damage the unit.

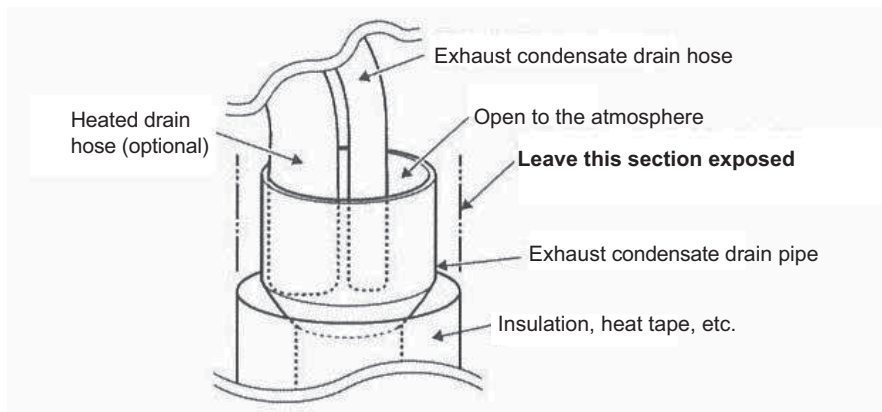

**[Unit]**

- Install heated drain hose (sold separately) in cold climate regions (areas where the outside air temperature can fall below 0°C). Refer to the installation manual included with the heated drain hose for installation method.
- The cold climate specification unit includes the heated drain hose in the engine compartment. Be sure to pull the hose out from the outdoor unit as explained in installation manual attached to the hose. Failing to pull out the hose will result in damage the unit.

## 2) Condensation water drain piping installation

- Accumulator condensate will drain from the condensation drain port. Direct water away from the unit by attaching a piece of generic hose. If water must be conveyed to a catch basin, install a drain pipe and route the hose into the drain pipe. In such case, take appropriate measures such as fastening the end of the hose to prevent the water from spilling outside. (If you connect the hose to hard PVC piping, secure the hose so that it cannot come loose.)

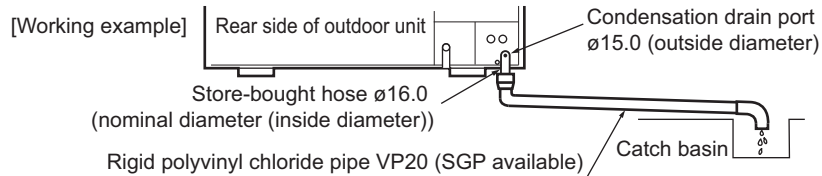

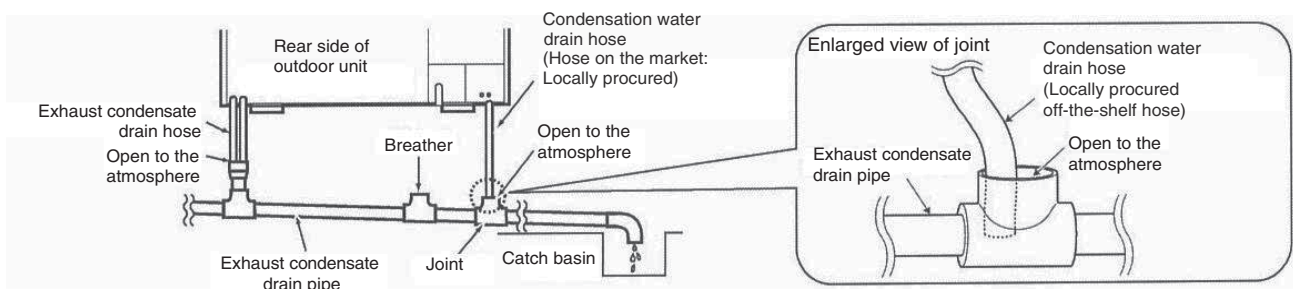

- If possible, avoid draining exhaust condensate and accumulator condensation through the same pipe. If use of a shared pipe cannot be avoided, be sure to follow the installation instructions given below. Otherwise, exhaust gas could enter the outdoor unit and cause a breakdown.
  - The joint between the condensation water drain hose and exhaust condensate drain hose must be open to the atmosphere. (Do not seal up the joint opening with the caulking material or other materials.)
  - Provide openings (breathers) upstream of the connecting points of the condensation water drain hose and exhaust condensate drain hose.
  - Be sure to follow the instructions and precautions in “Exhaust condensate drain piping installation” on page 43.



## 6. How to Extend the Exhaust Pipe

- Use KP (Kantan (=easy) Pipe) with a diameter of 100 mm for exhaust pipe extension.
- Ask an authorized dealer about KP.

### 1) Precautions for exhaust pipe extension

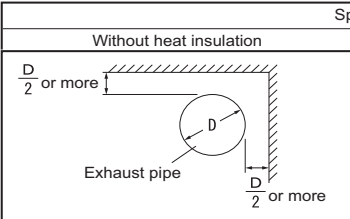
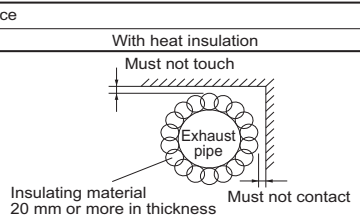
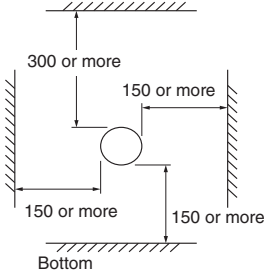
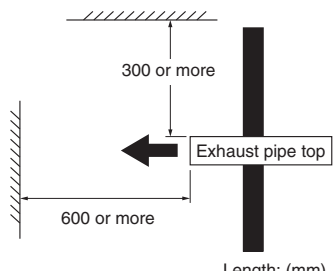
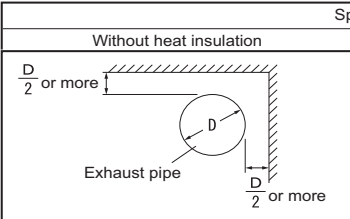
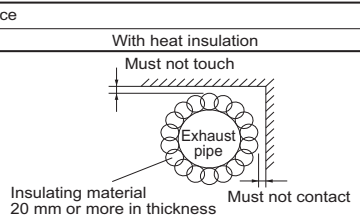
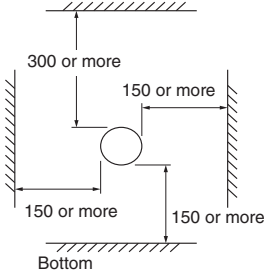
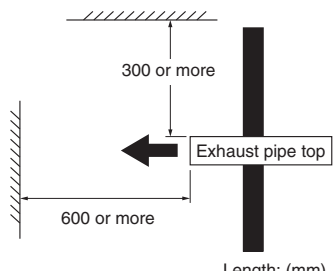
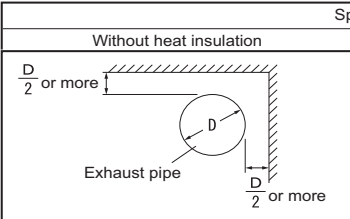
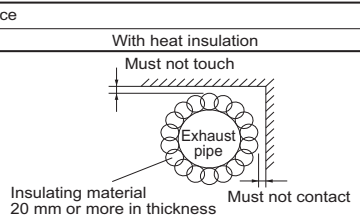
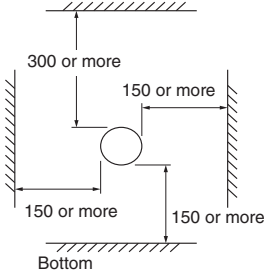
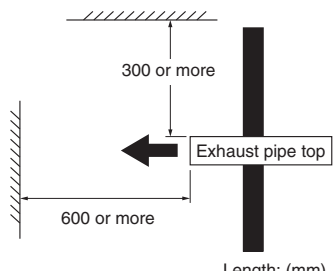
 <b>Warning</b>									
	<ul style="list-style-type: none"> <li>■ <b>Do not extend the exhaust pipe to a location where the exhaust gas could potentially enter a building.</b> If the exhaust pipe is extended to near the intake/exhaust port of the room, window or ventilation port, the exhaust gas could flow into the room and cause gas poisoning or accident due to lack of oxygen.</li> <li>■ <b>Do not extend the exhaust pipe to any area where flammable gasses are produced, handled, or vented, or where volatile flammable materials are handled.</b> Extension to such locations could result in a fire or an explosion.</li> </ul>								
	<ul style="list-style-type: none"> <li>■ <b>Be sure to discharge the exhaust gas directly to an outdoor area open to the atmosphere.</b> Accumulated exhaust gas could cause gas poisoning or an accident due lack of oxygen. Install the outdoor unit where adequate ventilation is provided.</li> <li>■ <b>Be sure to discharge the exhaust gas to the atmosphere in a place where it cannot adversely affect the surroundings.</b> If the exhaust gas is exhausted into a catch basin or ditch, it could be drawn into the room and cause gas poisoning or an accident due to lack of oxygen.</li> <li>■ <b>Be sure to discharge the exhaust gas to a location where it is not directed toward animals or plants.</b> Exposure to the exhaust gas or discharge air could harmfully affect animals or plants.</li> <li>■ <b>Be sure to maintain the appropriate clearance from the flammable or flame resistant material covering buildings in accordance with the following figure.</b> Inadequate clearance could cause a fire.</li> </ul> <ul style="list-style-type: none"> <li>• Distance from the exhaust pipe must be as follows.</li> </ul> <table border="1" style="margin-left: auto; margin-right: auto; border-collapse: collapse;"> <thead> <tr> <th colspan="2" style="text-align: center;">Space</th> </tr> <tr> <th style="text-align: center;">Without heat insulation</th> <th style="text-align: center;">With heat insulation</th> </tr> </thead> <tbody> <tr> <td style="text-align: center;">  </td> <td style="text-align: center;">  </td> </tr> </tbody> </table> <ul style="list-style-type: none"> <li>• Distance from the top end opening of the exhaust pipe must be as follows.</li> </ul> <table style="margin-left: auto; margin-right: auto;"> <tr> <td style="text-align: center;">  <p style="text-align: center;">Bottom</p> </td> <td style="text-align: center;">  <p style="text-align: center;">Exhaust pipe top</p> <p style="text-align: center;">Length: (mm)</p> </td> </tr> </table>	Space		Without heat insulation	With heat insulation			 <p style="text-align: center;">Bottom</p>	 <p style="text-align: center;">Exhaust pipe top</p> <p style="text-align: center;">Length: (mm)</p>
Space									
Without heat insulation	With heat insulation								
									
 <p style="text-align: center;">Bottom</p>	 <p style="text-align: center;">Exhaust pipe top</p> <p style="text-align: center;">Length: (mm)</p>								
	<ul style="list-style-type: none"> <li>● Try to avoid extending the exhaust pipe in areas where the outside temperature falls to 0°C or less because the inside of the exhaust pipe may freeze.</li> </ul>								



## 2) Exhaust pipe extension

- Extended the exhaust pipe according to the following procedure by referring to the figure below.
  1. Remove the exhaust top from the outdoor unit exhaust port.
  2. Connect the KP (Kantan Pipe) sequentially from the outdoor unit side, and extend the exhaust pipe to the desired position following the restriction below. (Refer to Figure A.)
    - Total length of the exhaust pipe extension shall not exceed 15 m.
    - Total number of bends (bend angle = 90 °) shall not exceed 5 (each one = 1 m equivalent).
    - The extended pipe shall be anchored to the building or similar structure with fixing brackets every 1.5 to 2 m.
    - The exhaust pipe shall not be clustered with or connected to other exhaust pipes.
  3. Attach the exhaust top to the outlet end of the extended exhaust pipe paying attention to the following:
    - The angle of the exhaust vent plane shall be vertical to the ground by adjusting the elbow pipes so that rainwater may not enter the exhaust pipe directly.
    - Apply silicone caulking material to the lower part of the metal mesh in accordance with the following figure so that the water can not drip from the exhaust top. (Refer to Figure B.)
- When extending the exhaust pipe using an antivibration mount, follow the exhaust pipe extension method to perform work. (The pipe cannot be fixed to a building, etc.)
- When an outdoor unit is installed on the antivibration mount, the exhaust pipe may come off due to vibration. In such a case, the only method to extend it is as shown in the figure on the lower-right side. (Refer to Figure C.)

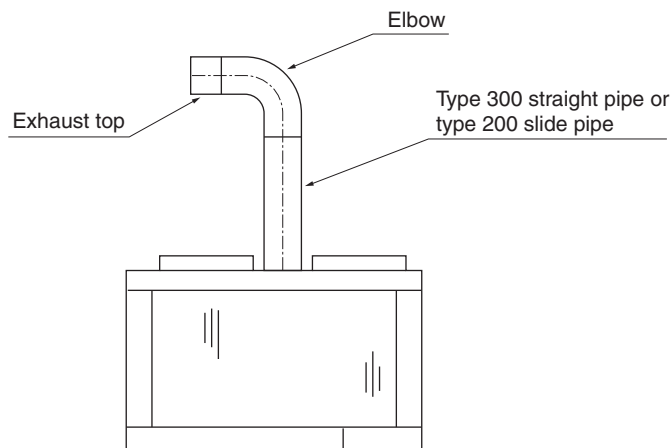
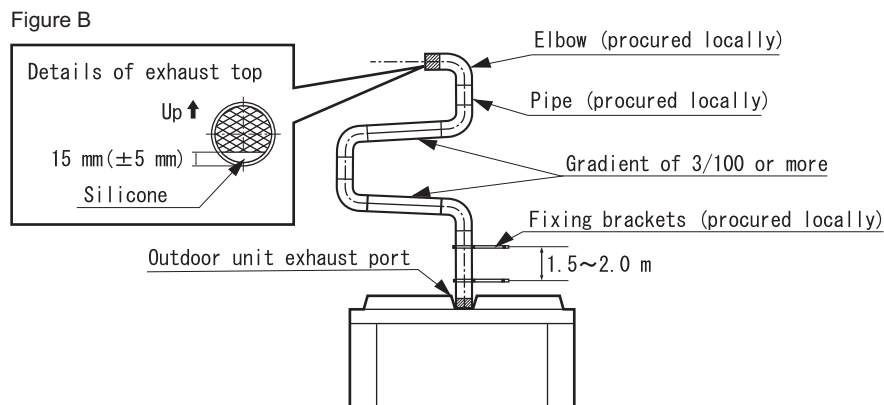
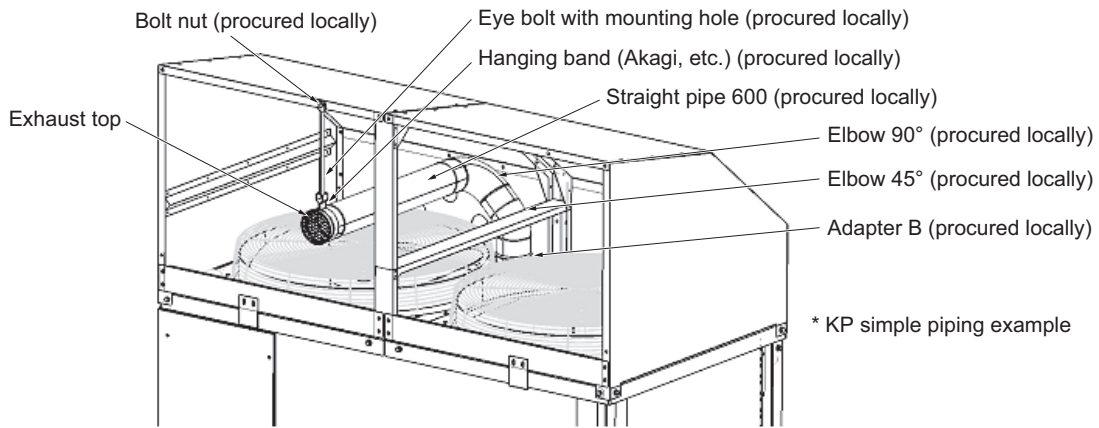

Figure C

- When a snowproof hood is installed on the outdoor unit, its interior may freeze due to exhaust in a cold or snow-covered region. Extend the exhaust pipe to take the appropriate measures. To extend the exhaust pipe with a snowproof hood installed, refer to the figure below.



### 3) Installation check

- Make sure that there is no leakage of exhaust gas or exhaust drain water from the exhaust pipe joints by performing a test operation after completing the exhaust pipe extension.

## 7. Summary of Electrical Wiring Installation

### Warning



- **Use a dedicated branch circuit. Never use the outdoor unit with other appliances on the same circuit.**

If the outdoor unit and other appliances are used on the same circuit, secondary damage could occur due to breaker tripping.



- **All electrical installation work must be performed by a certified electrician in accordance with the relevant local and national regulations, technical standards, and instructions provided in this manual.** Improper installation could result in electrical shock, fire or other hazards.

- **Provide an electric leakage breaker with the specified capacity for each outdoor unit (sensitivity amperage is 30 mA).**

If the electric leakage breaker is not installed, electrical shock could occur.

- **Provide an over-current breaker with the specified capacity for each outdoor unit.**

If the proper over-current breaker is not installed, overheating, fire or secondary damage due to the breaker tripping could occur.

- **Always use the designated cable for wiring. Make sure that the cable is properly connected and fastened so that the outside forces may not be transferred to the terminal connection.**

Improper connecting or fastened can result in overheating, fire or other hazards.

- **Always ground the unit in accordance with the relevant technical standards.**

Improper grounding can result in electrical shock.

- **Before starting the electric wiring construction, check to ensure that the power is turned off.**

Not doing so could cause an electrical shock or fire.

### 7-1. Opening for power supply wires / signal wires

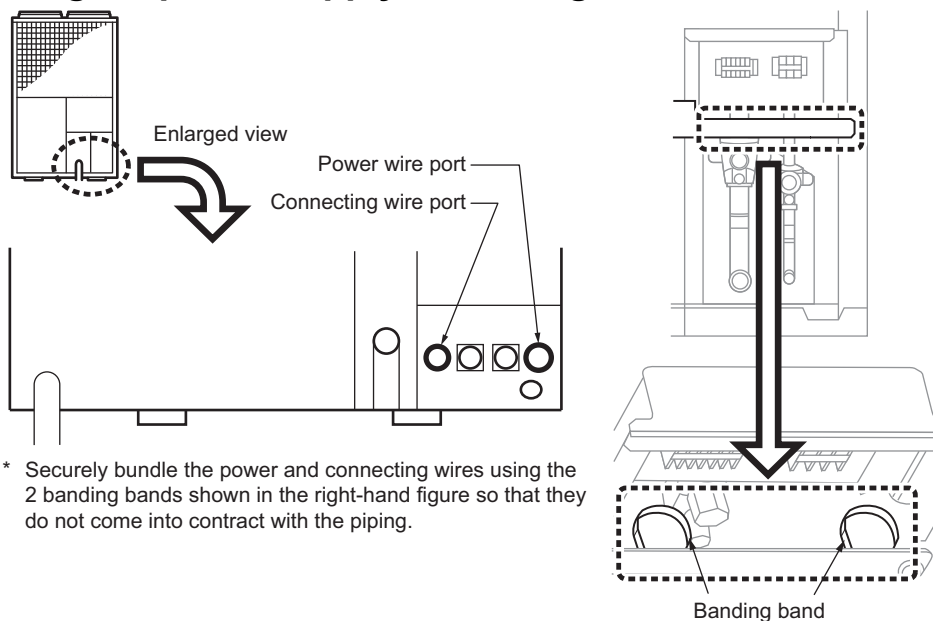

#### Important

- In combined installation of P710 and P850, be sure to set P850 as the “sub unit”.

## 7-2. Precautions regarding electric wiring connections

### Important reminder

- To connect to the terminal block, use a “solderless terminal”.
- To tighten the terminal screws, use the appropriate screwdriver.

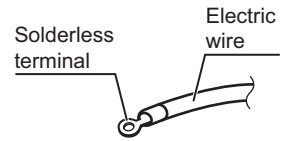

### 1. Precautions regarding electric wiring connections

- To connect the electric wiring to the terminal block, use the following solderless terminal or an appropriate equivalent.

Solderless terminal			
M4	Power wiring terminal block	V2-4 or V5.5-4 (stranded wire only)	Locally procured
		R2-4 or R5.5-5 (single wire or stranded wire)	
M3	Connecting wiring terminal block	V1.25-B3A	Locally procured

- For wiring, securely connect the specified electric wires, and fix them so that no external force is applied to the terminal part.
- If the terminal screw is tightened excessively, it may damage the screw.  
For the tightening torque of the terminal screw, refer to the following table.

Tightening torque (N·m)		
M4	Power wiring terminal block	1.5 to 2.1
M3	Connecting wiring terminal block	1.0 to 1.8

- “Up to 2 wires” can be connected to a single terminal. Never connect “3 or more wires”.
- When connecting 2 wires to a single terminal, place them back-to-back. In this case, be careful so that the small-diameter wire is placed on the large-diameter one.

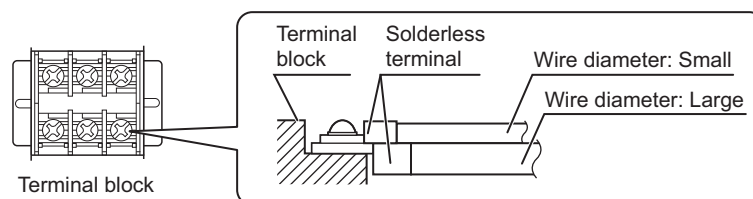

### 2. Precautions after electric wiring has been completed

- After electric wiring has been completed, check each electrical component for disconnected connectors, removed terminals, slackness, and looseness.

### 7-3. Wiring example

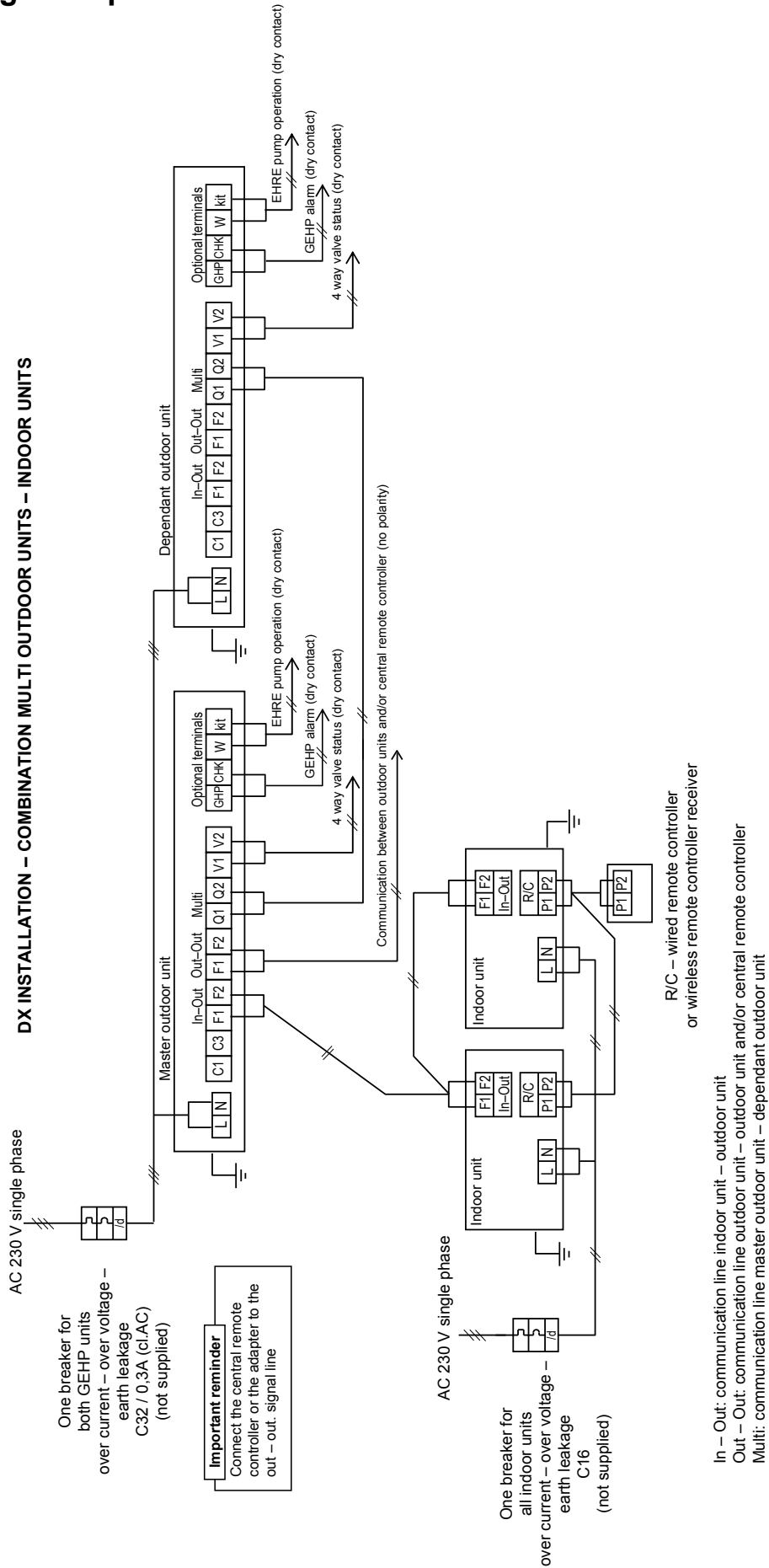

### DX INSTALLATION – STAND-ALONE OUTDOOR UNIT – INDOOR UNITS

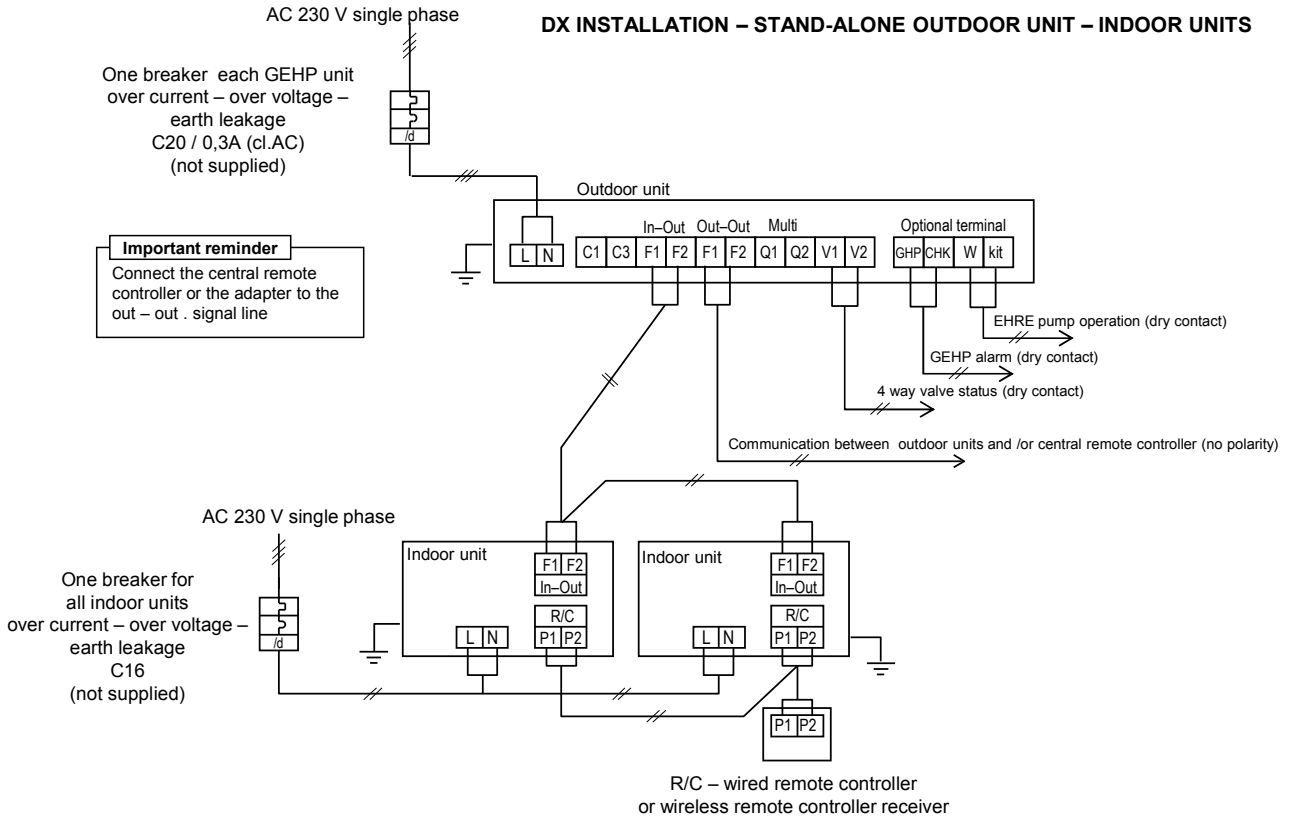

In – Out: communication line indoor unit – outdoor unit  
 Out – Out: communication line outdoor unit – outdoor unit and/or central remote controller  
 Multi: communication line master outdoor unit – dependant outdoor unit

### AWS INSTALLATION – SINGLE UNIT

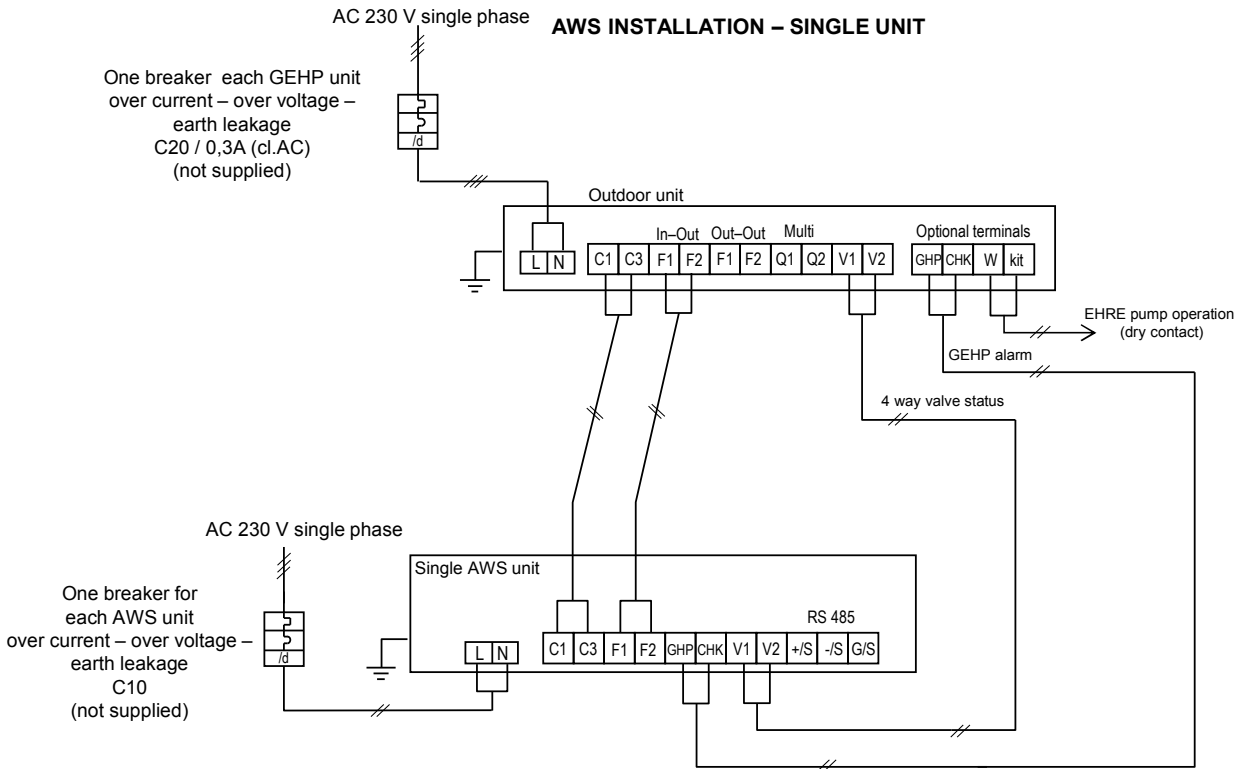

In – Out: communication line AWS – outdoor unit  
 Out – Out: not in use in AWS installations  
 RS485: communication line AWS – expansion modules

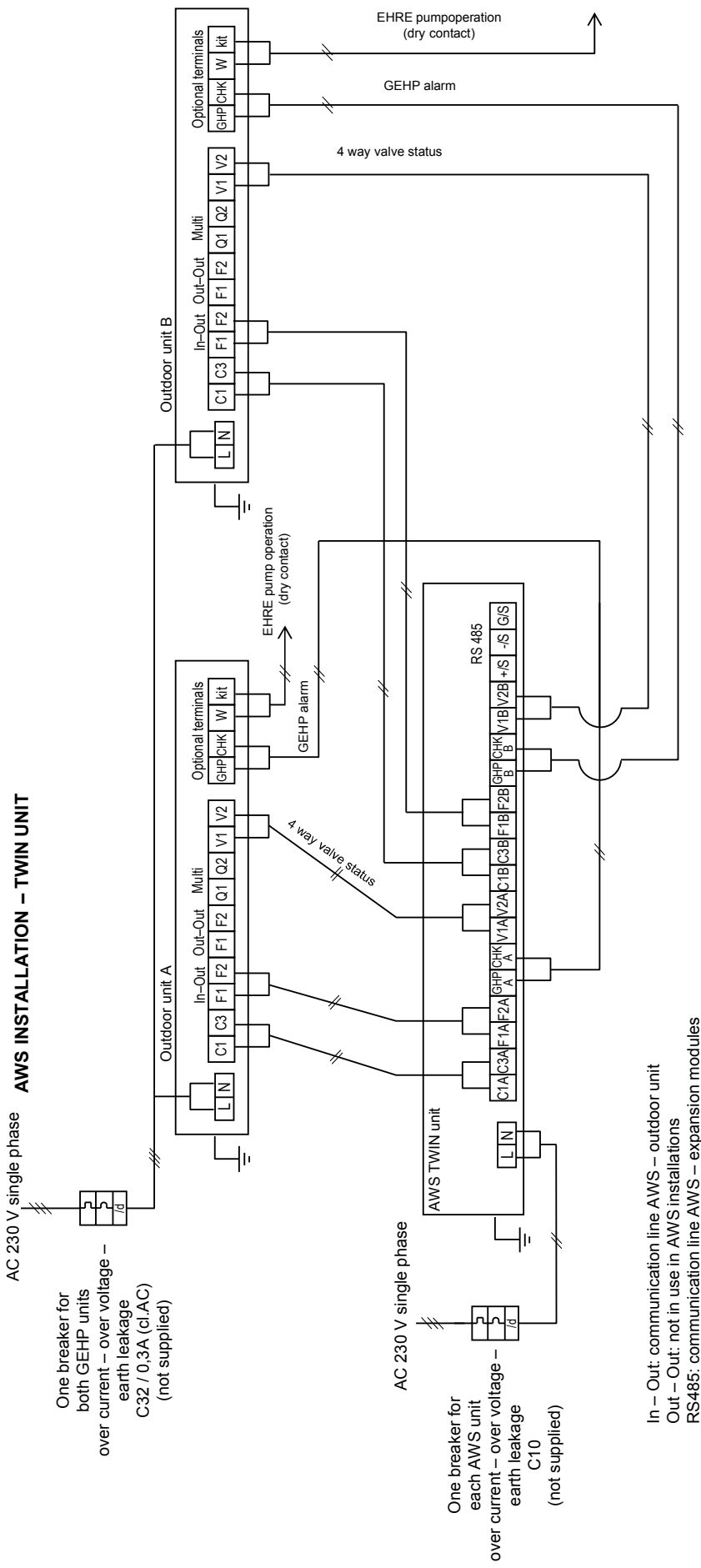

AC 230 V single phase

One breaker for both GEHP units over current – over voltage – earth leakage C32 / 0,3A (cl.AC) (not supplied)

AC 230 V single phase

One breaker for each AWS unit over current – over voltage – earth leakage C10 (not supplied)

In – Out: communication line AWS – outdoor unit  
 Out – Out: not in use in AWS installations  
 RS485: communication line AWS – expansion modules



## 8. Electrical Wire Specifications and Precautions

### 8-1. Power supply wire

 <b>WARNING</b>
 <ul style="list-style-type: none"> <li><b>AISIN GEHP electrical wiring specification and conductor size must be in accordance with the relevant local and National regulations and technical standards.</b> Improper wiring can result in overheating, short circuit or fire.</li> </ul>

- Use copper conductors only for the installation of power wires.
- Use multi core PVC insulated wires only, which comply with the standard IEC60245.
- Select the cable type and size in accordance with the relevant local and National standards.
- Always ground the unit in accordance with the relevant local standards. Use a ground wire of  $\varnothing 2 \text{ mm}^2$  or more secured to the designated grounding screw.
- Power supply line for indoor units and/or AWS must be separated from the power supply line to the AISIN GEHP outdoor unit.

#### <Combined installation>

The table below indicates minimum cross section and maximum length in case of both AISIN GEHP units connected under the same breaker.

Outdoor units	Supply voltage (V)	Earth leakage breaker		Power supply wire	
		Rated current (A)	Sensitivity (mA)	Min. cross section (mm <sup>2</sup> )	Max length (m)
P450 + P450	AC 230 1P +N	32	30	3,5 [5,5]	29 [46]
P450 + P560					25 [40]
P560 + P560					23 [36]
P560 + P710					18 [29]
P710 + P710					16 [25]
P710 + P850					14 [23]
P850 + P850					13 [21]

\* Figures in brackets indicate maximum length in case power supply wire cross section is increased to 5,5 mm<sup>2</sup>

#### <Stand-alone installation>

The table below indicates minimum cross section and maximum length in case each AISIN GEHP unit is connected under a single breaker.

Outdoor units	Supply voltage (V)	Earth leakage breaker		Power supply wire	
		Rated current (A)	Sensitivity (mA)	Min. cross section (mm <sup>2</sup> )	Max length (m)
P450 [16 HP]	AC 230 1P +N	20	30	3,5	58
P560 [20 HP]					46
P710 [25 HP]					32
P850 [30 HP]					27

\* Figures in brackets indicate maximum length in case power supply wire cross section is increased to 5,5 mm<sup>2</sup>

- The values in the tables above are reference based on the minimum requirements for proper installation. In case of stricter local standards, make sure to comply with relevant requirements.
- The maximum allowed voltage drop on the maximum line length is 2%. Increase the wire thickness in case of higher voltage drops.
- Always install over current, over voltage, earth leakage breaker as indicated above to protect the AISIN GEHP outdoor units. Both units of combined installations can be protected by the same breaker.
- Always refer to the dedicated installation manual for the power supply wiring of indoor units and/or AWS.



## 8-2. Signal wire between indoor-outdoor units, outdoor-outdoor units, and between combined outdoor units

### Important reminder

- Never mix signal and power supply (230 V) wires in the same multiple core cord. This will cause malfunction. In addition, provide 50 mm or more clearance between wires to prevent electrical noise interference.

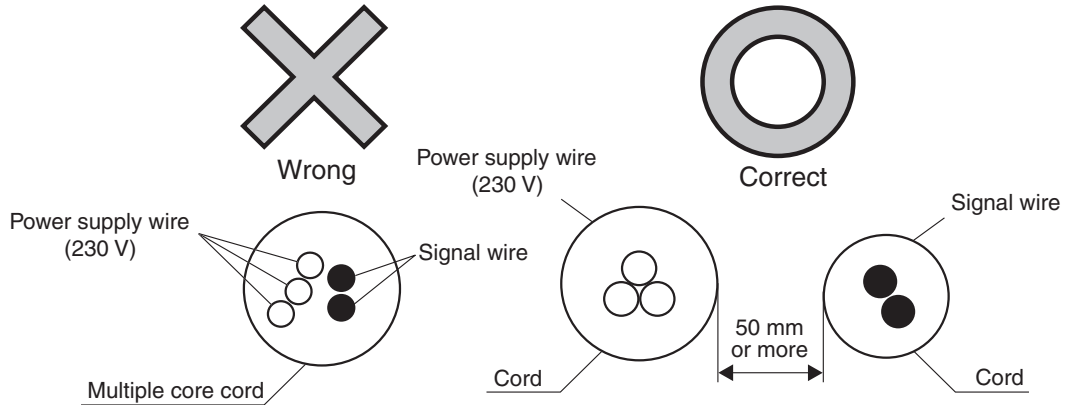

- Always use shielded wire when installing the outdoor unit near high-frequency medical equipment, high-frequency welding equipment or any other equipment that generates high-frequency waves. Otherwise, malfunction could occur due to high-frequency interference.
- When using shielded wires, always ground just one side. Otherwise, communication problems could occur.
- Never use multiple core signal wires having more than two cores.
- Wire thickness must not exceed the range from 0.75 mm<sup>2</sup> to 1.25 mm<sup>2</sup>.
- Do not bundle the signal wires with the power supply wires.
- To prevent electrical noise interference, physically isolate the signal wires from power supply wires as indicated below.

Capacity of power source		Isolation distance between power supply and signal wires (mm)	
		This system	Other equipment
230 V or less	10 A or less	50 mm or more *1	300 mm or more
	50 A or less		500 mm or more
	100 A or less		1000 mm or more
	Over 100 A		1500 mm or more

\*1 Because this system generates very little noise, isolation distance of 50 mm or more is enough.

- Signal wires between indoor-outdoor units, between outdoor-outdoor units, and between combined outdoor units have no polarity.
- The length of the signal wires between indoor-outdoor units and outdoor-outdoor units must not exceed the following:
  - Longest wiring length: 1000 meters
  - Total wiring length: 2000 meters

The length of the signal wire between combined outdoor units must not exceed 30 meters.

- Use M3 crimp terminals to connect wires to the terminal block.
- Be sure to use vinyl sheathed wire or cable with 2 cores for signal wire in accordance with the relevant local and national regulations and technical standards.

### 8-3. Remote control wire

- Connect the ends of the remote control wire (P1,P2) to the indoor unit terminals (P1,P2). (The P1 and P2 terminals have no polarity.)

#### Wire specifications

Type of wire	Vinyl sheath cord or cable
Thickness	0.75 to 1.25 mm <sup>2</sup>

- Peel the sheathed part of the wire passing through the inside of the remote controller case.

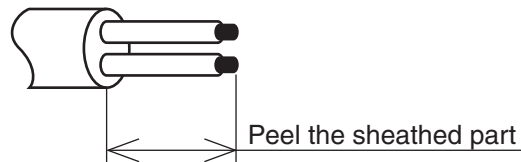

#### Important reminder

- When installing the wiring, be sure to keep signal wires away from the power supply wires so that the signal wires are not affected by electrical noise (external noise).

# 9. Power Supply Wiring Procedure

## 9-1. Wiring instruction

### ◆ Combined installation

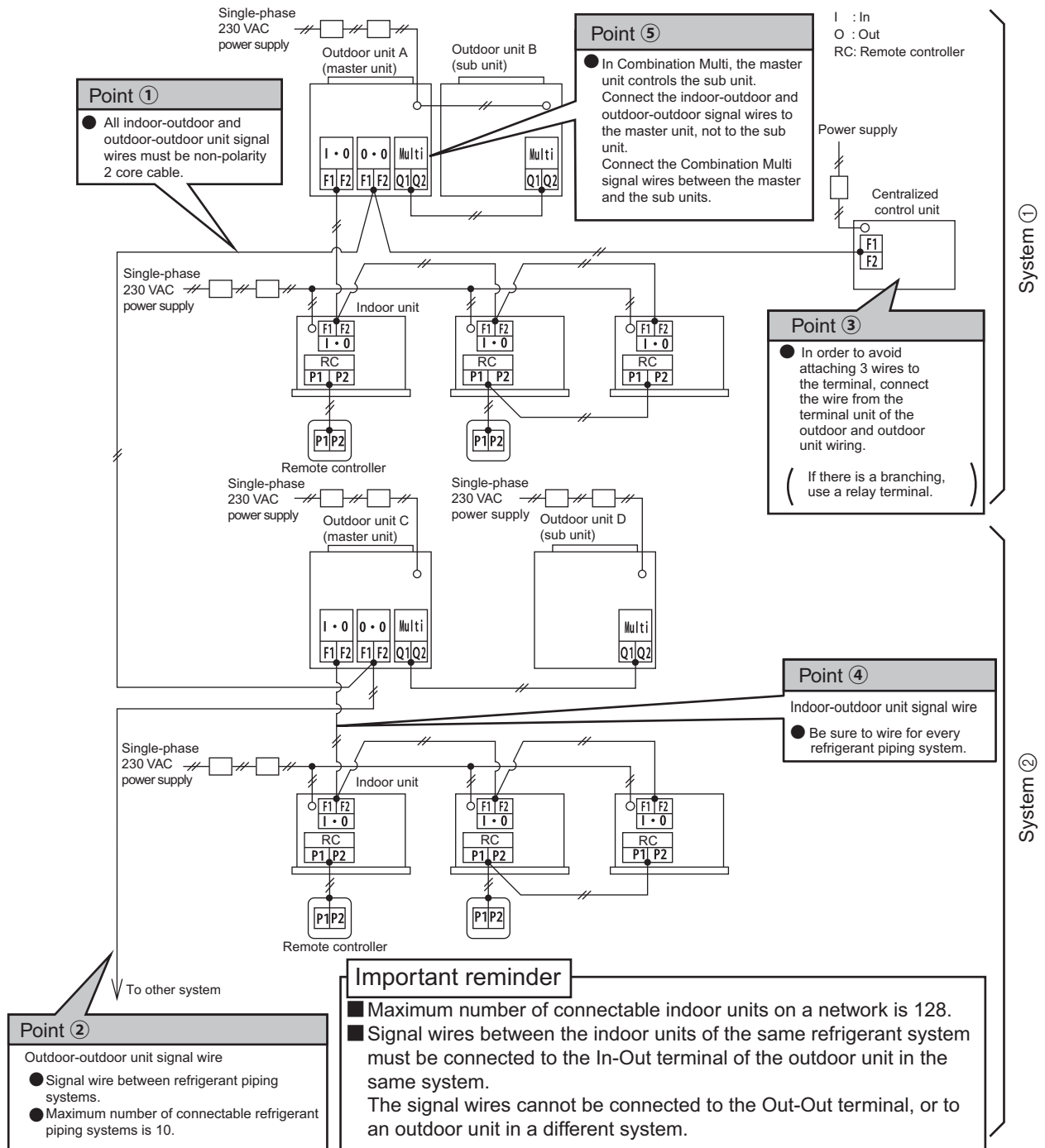

# ◆ Stand-alone installation

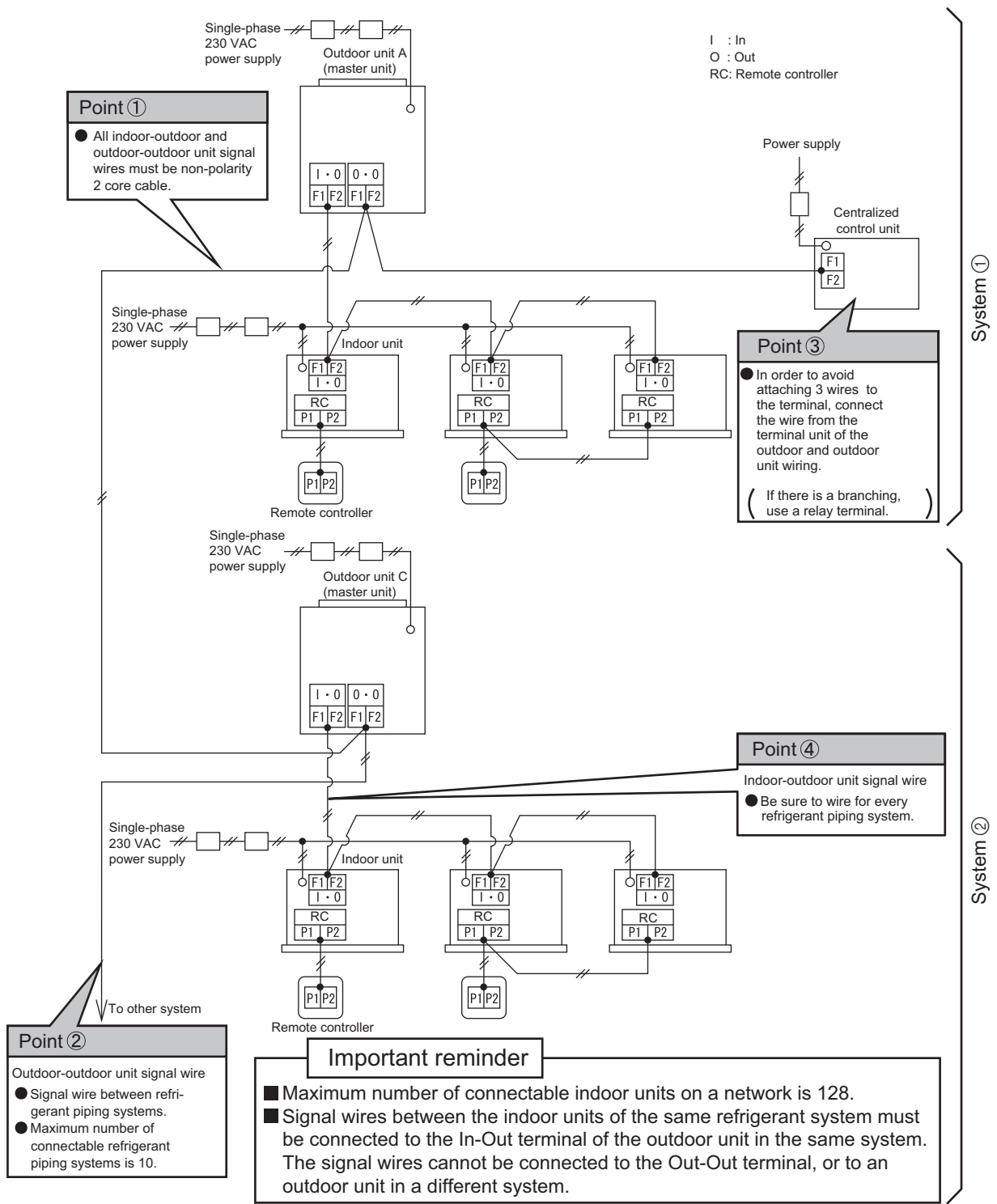

## 9-2. Wiring length

Wiring of indoor-outdoor and outdoor-outdoor signal wires (excluding wiring of the remote controller) must not exceed the following lengths:

- Longest wiring length: 1000 meters
- Total wiring length: 2000 meters  
(When using shielded wires, the total wiring length is restricted to 1500 meters.)

### ■ System example

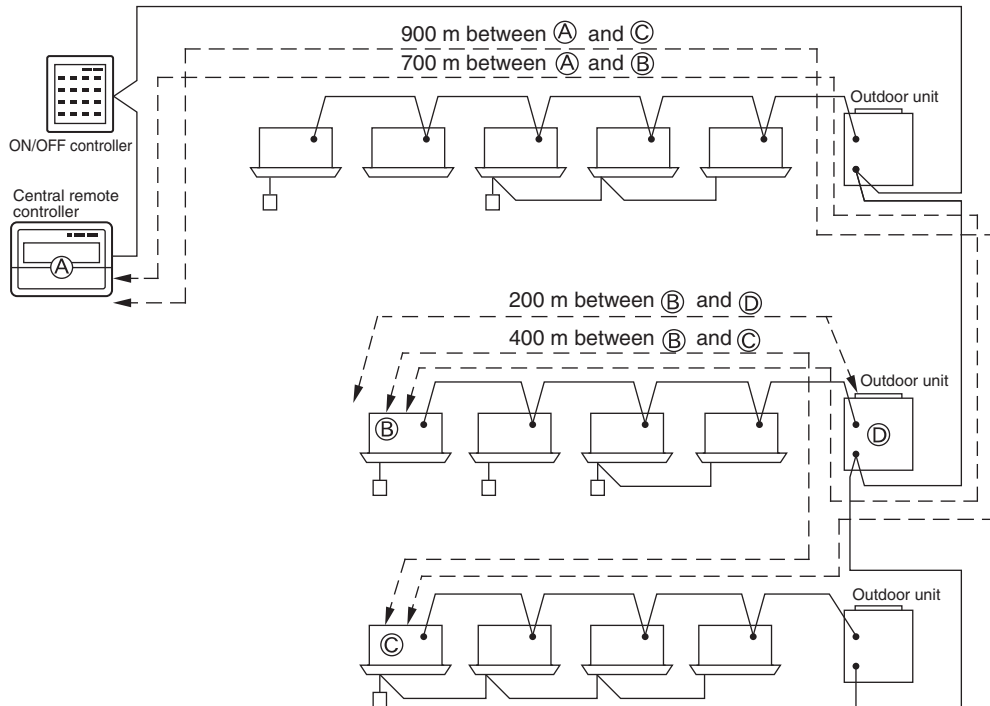

- In the above system, the longest wiring distance is 900 m between ① and ③, which satisfies the longest wiring length limit of 1000 m. The total length, which is the total of 900 m between ① and ③, and 200 m between ② and ④ is 1100 m. This also satisfies the total wiring limit of 2000 m. The system functions properly only when both the longest wiring length and the total wiring length are within the limits as shown above.

#### Important reminder

- Be sure to check the longest wiring length and the total wiring length at the time of system design.  
If the length exceeds the acceptable range, consider dividing the system or installing a D III -NET extension adapter (sold separately).

### ■ Signal wire length between combined outdoor units

Signal wire length between combined outdoor units must be 30 m or less.

### 9-3. Branch wiring

The following 3 wiring methods are acceptable. (Up to 16 outdoor units can be connected. (\*))

#### ■ Series wiring

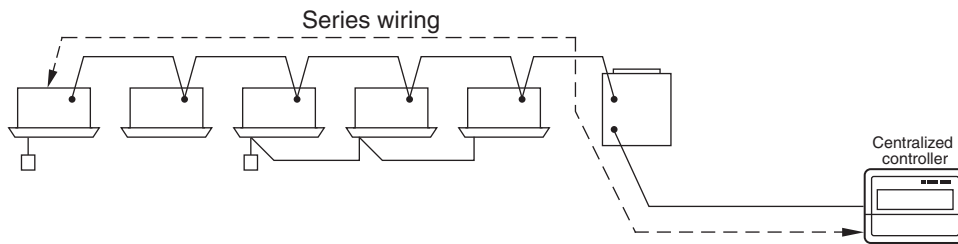

#### ■ Bus wiring (Up to 16 branches, sub-branches off of the first level of branches are not possible)

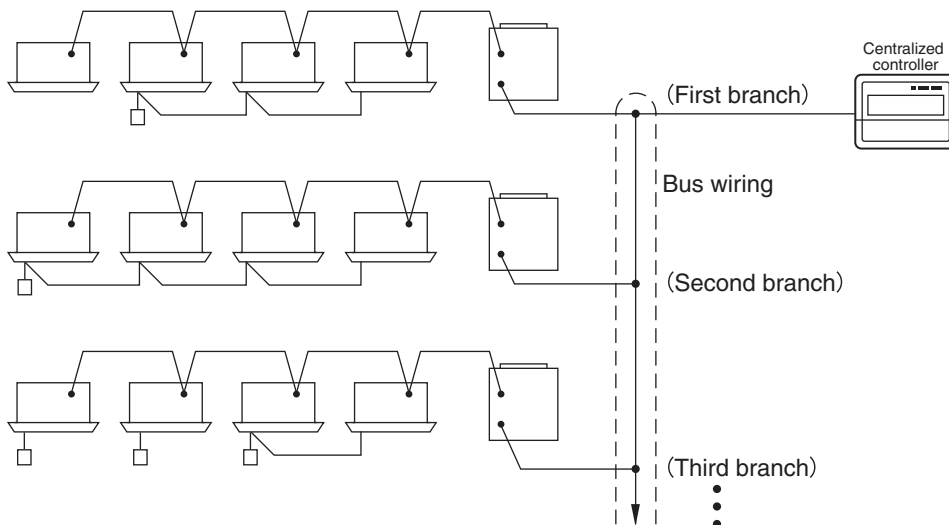

#### ■ Star wiring (Up to 16 branches, sub-branches off of the first level of branches are not possible)

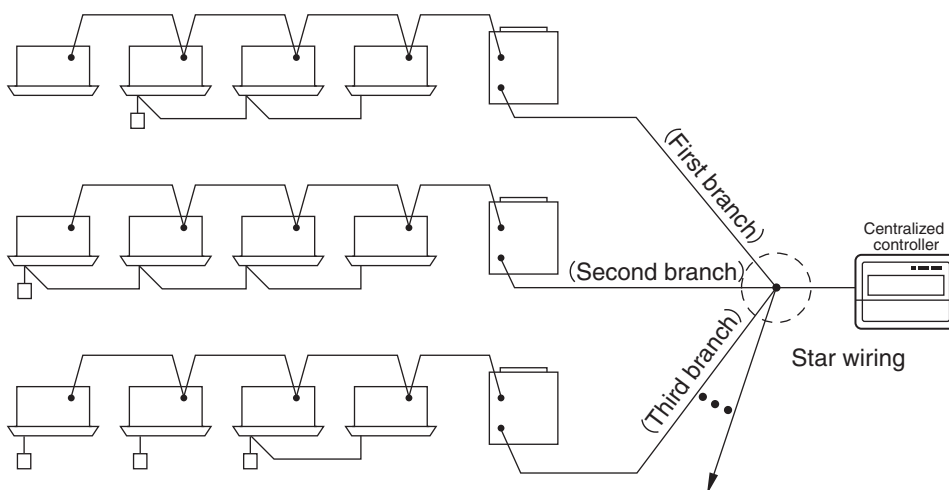

(Note) Although the above figures show the examples using the centralized controller, the same wiring system can be used with other centralized control devices.

- \* When the number of connected outdoor units exceeds 16, use the DIII-NET extension adapter. However, even when the number of connected outdoor units is below 16, if a communication error occurs, connect the DIII-NET extension adapter. With recent advances in intelligent building functions, the number of communication equipment items and length of wiring has increased, which may affect DIII-NET communications. Even when the number of connected outdoor units is below 16, connect the DIII-NET extension adapter depending on conditions.

---

# 10. Reusing existing piping

---

## 10-1. Notes for renewal specification (reusing existing piping)

When performing renewal installation (reusing existing piping), read this manual and "Gas heat pump air conditioner renewal manual" carefully, and install the unit properly according to the contents of the manuals. Improper installation will not realize the unit's full performance potential and could even cause damage to the unit.

### ■ Items to be checked for renewal installation

#### 1) Installing outdoor units

- Be sure to use M 12 anchor bolts if the anchor bolts are smaller than M12. If the location of the anchor bolts is different from the bolt location of this unit, location change is necessary. (Refer to "3-3. Foundation and anchor bolt specifications" on page 11.)
- When performing renewal installation from EHP, check the strength and size of the foundation. Foundation change is necessary if the strength is insufficient.
- When performing renewal installation from EHP, install an antivibration mount if a vibration problem is likely to occur. (Refer to "3-3. 3) Antivibration mount" on page 12.)

#### 2) Installing indoor units

- Because the location of the suspension bolts for the indoor units are changed, install the indoor units according to the new indoor unit specification.

#### 3) Fuel gas piping

- Replace the reinforced gas hose of the existing outdoor unit with the new hose. (Gas hose change is required if the gas piping connecting location or connection size is different between the existing outdoor unit and new outdoor unit.) (Refer to "5. Fuel gas piping installation" on page 37.)
- When performing renewal installation from EHP, new installation of the fuel gas piping is required.

#### 4) Refrigerant piping and refrigerant oil

- Design pressure of the pipes and branch pipes must be 3.3 MPa or higher. Check that the pipes have no corrosion.
- The height difference between the indoor and outdoor units, and between indoor units must be within specification range of the new outdoor unit (AISIN GHP). (Refer to "4. Refrigerant Piping" on page 13.)
- Once the existing outdoor units or indoor units are removed, block the refrigerant pipes with a tape as soon as possible to prevent water or dust from entering the piping.
- If the pipe size is different between existing piping and renewal unit piping (including indoor unit piping), connect the pipes by changing the size with the reducer or other means.
- Look into the trouble history of the existing units. Check if there were any troubles such as compressor failure or refrigerant shortage possibly due to piping failure. If there are such trouble histories, check if the troubled part was repaired. If the troubled part was not repaired, repair the part.
- Clean up the piping if there is a history of compressor failure.
- If the thermal insulation or lagging of the existing piping is deteriorated, repair the insulation or attach the new insulation.
- Pay attention to the refrigerant oil. Piping cleaning is necessary depending on the refrigerant oil type. (Refer to "Gas heat pump air conditioner renewal manual".)
- The piping without insulation on the liquid pipe can not be used.
- The flare nuts connected to the existing indoor units must be replaced with the flare nuts attached to the new indoor units.

## 11. Various Function Settings

### Warning



- **Make sure that all the electric wiring constructions have been completed before turning the power breaker on.**  
Not doing so could cause an electrical shock or fire.
- **When touching the heat exchanger fan of the outdoor unit, always turn the power breaker off.**  
Doing so could cause you to be caught in the equipment, resulting in an injury. To maintain the functionality, the heat exchanger fan of the outdoor unit may drive regardless of which operation is performed.

All function settings of the outdoor unit in this model are performed by board maintenance function.

### 11-1. Address setting method of the indoor and outdoor units

- The address setting of the outdoor and indoor units is performed automatically.
- When the centralized remote controller is added, set the centralized address to the indoor units with the standard remote controller.

### 11-2. EEP (electronically erasable programmable) dip switch settings

This model has EEP dip switches inside the outdoor unit circuit board.  
Refer to “List of EEP dip switch settings” on the following page for the contents of the switches and the factory default settings.

### Warning



- **Be sure to change the #4 bit of #1 EEP dip switch to “ON” when the deodorizing option is installed.**  
Otherwise, the protection device may operate improperly and smoke, fire or malfunction could occur.

### Caution



- **Do not touch moving parts (fans or engine belt).**  
You could be caught by moving parts and injured.  
The fans or engine may automatically start running to protect the device to maintain performance even if the GHP is stopped.  
Be sure to turn OFF the power breaker when you need to handle moving parts.





## WARNING



- **EEP dip switch settings can be changed by local AISIN Authorised Service Centre only. Factory settings may change depending on the unit version.** Failure to observe this prescription makes the warranty no longer valid.
- **In case EEP dip switch settings on the pc board must be changed, always refer to the local AISIN Authorised Service Centre.**

### List of EEP dip switch settings

EEP dipswitch	Pin n.	Functions	Allowed selection	Factory setting
1 Setting can be changed with PC board code 80	1	Periodic inspection notification	ON = enabled OFF = disabled	ON
	2	Not in use		
	3	Snow blowing function	ON = enabled OFF = disabled	Cold district spec ON All other spec OFF
	4	Exhaust gas temperature for catalyser	ON = enabled OFF = disabled	Units with catalyser ON Units without catalyser OFF
	5	Conditional silent mode *	ON = enabled OFF = disabled	OFF
	6	Energy saving mode **	ON = enabled OFF = disabled	OFF
	7	Combination multi automatic backup *	ON = enabled OFF = disabled	ON
	8	European specification		Do not change
2 Setting can be changed with PC board code 81	1	Not in use	-	OFF
	2	Not in use	-	OFF
	3	Gas type setting determination	ON = enabled OFF = disabled	Depends on model type Do not change
	4	Not in use	-	OFF
	5	Not in use	-	OFF
	7	Not in use	-	OFF
	8	Not in use	-	OFF
	3 Setting can be changed with PC board code 82	1	European specification	-
2		Not in use	-	OFF
3		Not in use	-	OFF
4		Not in use	-	OFF
5		Not in use	-	OFF
6		Not in use	-	OFF
7		Not in use	-	OFF
8		Not in use	-	OFF
5 Setting can be changed with PC board code 84	1	Operation mode switchover setting	ON = Outdoor unit OFF = Indoor units	DX spec OFF AWS and AHU Easy spec ON
	2	Operation mode selection privilege	OFF	ON
	3		not possible	ON
	4		OFF	ON
	5	European specification	OFF	ON
	6	European specification	sub collective	ON
	7	Not in use	individual	ON
	8	Not in use		
6 Setting can be changed with PC board code 85	1	Not in use	-	OFF
	2	Not in use	-	OFF
	3	Not in use	-	OFF
	4	Not in use	-	OFF
	5	Not in use	-	OFF
	6	Engine Heat Recovery Energy EHRE	ON = enabled OFF = disabled	Units with EHRE ON Units without EHRE OFF
	7	Not in use	-	OFF
	8	Not in use	-	OFF

\* In case of combined installations, the setting of the master outdoor unit is automatically set in the sub outdoor unit.

\*\* When energy saving mode setting is ON, the outdoor unit limits the rated output to reduce consumptions. Performances can be lower than declared on the label. Do not use this function in case the indoor units connected capacity exceeds 100% of the outdoor unit capacity.

EEP dip switch setting is set in the “check mode”. Disconnect the personal computer, and then, select the check mode.

### 1) How to change the monitor mode to the check mode

- 1 Press the MODE SELECT switch. The mode LED (LED15) lights up in green.  
(Current mode changes to the monitoring mode)
  - 2 Press and hold the SET and CLEAR switches at the same time. The mode LED (LED15) lights up in red.  
(Current mode changes to the check mode)
- \* The monitor mode cannot be shifted to the check mode in the 20 seconds after the power is turned on, during system operation, or when the fan or water pump are operating.
- \* The monitor mode cannot be shifted to the check mode during remote control operation.

### 2) Changing EEP dip switch settings

- 1 Press the CODE No. UP or CODE No. DOWN switch to select check codes 80 to 85 as follows.  
(Refer to “List of EEP dip switch settings” on the previous page for the details about EEP dip switch functions.)

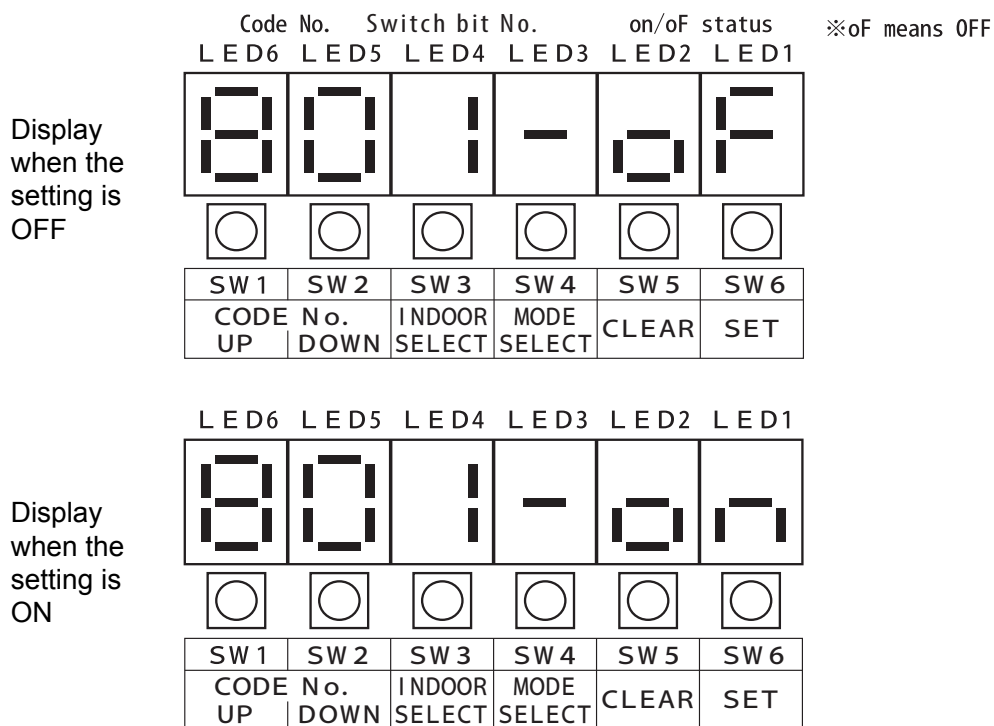

- 2 Select the switch pin number by pressing the INDOOR SELECT switch.  
(The display rotates through the sequence 1 → 2 → ··· → 8 → 1 each time you press the switch.)
  - 3 Press the SET switch. LED1 and LED2 start to flash. At this time, the on/oF setting can be changed by pressing the CODE No. UP or CODE No. DOWN switch.  
(Each press of either the CODE No. UP or DOWN switch changes the setting between on and oF.)
  - 4 After selecting oF or on, press the SET switch to confirm the new setting. The display stops flashing and lights steadily.
- \* If you press the CLEAR switch while the display is flashing, the display stops flashing and lights steadily and the current settings are not changed.

## 11-3. Gas type setting

### Warning









- **Gas type selection must be changed by AISIN Authorised Technical Service Centre qualified personnel. Factory settings are chosen depending on the GHP version.** Failure to observe this prescription makes the warranty no longer valid.
- **If, by any chance, changing the gas type setting is necessary, please contact with the AISIN Authorised Technical Service Centre.**
- **The installation of catalyser and further components may be needed when changing gas type to LPG. Please contact with the AISIN Authorised Technical Service Centre.**

Gas type setting is set in the “check mode”. Disconnect the personal computer, and then, select the check mode. To select the check mode, refer to “12-2. 1) How to change the current mode to the check mode” on the previous page. The AISIN GHP can work with several supply gas types. Gas type can be chosen by adjusting one setting of the outdoor unit PC. In some cases it can be necessary to install a catalyser and/or replace the gas mixer.

### 1) How to set the gas type

1. Press the CODE No. UP or CODE No. DOWN switch and select the check code No. 76 as follows.

Code No.		Gas type			
LED6	LED5	LED4	LED3	LED2	LED1
7	6			1	3A
					
SW 1	SW 2	SW 3	SW 4	SW 5	SW 6
CODE No. UP	CODE No. DOWN	INDOOR SELECT	MODE SELEC	CLEAR	SET

※ When 13A is selected.

2. Press the SET switch. LED1 to LED4 start to flash. At this time, the gas type can be changed by pressing the CODE No. UP or CODE No. DOWN switch. (Refer to the following table for the details about the gas type). If you press the CLEAR switch while the display is flashing, you can go back to the previous screen without changing the gas type.

Display	Gas type
13 A	NATURAL GAS G20 (H erdgas)
12 A	NATURAL GAS G25 (L erdgas)
iPro※	LPG (G30/G31)
H or E	Not in use

3. After selecting the gas type, press and hold the SET switch to input the current setting. The display stops blinking and the selected gas type is shown.
4. Exit the check mode by pressing the MODE key for more than three seconds. The indoor unit recognition procedure starts back.

※ Propane – Butane mixtures are allowed up to 70% Propane and 30% Butane. Other mixtures, outside the indicated range, are not allowed. When changing gas type to LPG, it is compulsory to install the optional catalyser kit to be ordered separately.



### Installation of the external gas regulator

Whereas the supply gas pressure was higher than the prescribed one, indicated on the AISIN GHP plate, or anyway LPG (G30/G31) is used as supply gas, install an external gas regulator, such as the on described in the figure.

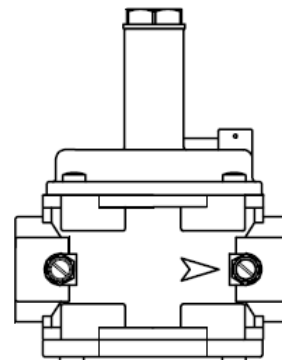
(eg. Madas model RG/2MTA DN 20 20 – 60 mbar or similar, CE marked, EN88 compliant).







## 11-4. Installation of catalyser

 <b>WARNING</b>	
	<ul style="list-style-type: none"> <li>• <b>NEVER</b> the AISIN GEHP outdoor unit run with other than the gas type indicated in the calibration label. Before using different gas types, change the EEP dip switch setting and install the catalyser, where prescribed. Failure to observe this prescription makes the warranty no longer valid.</li> </ul>
	<ul style="list-style-type: none"> <li>• <b>The installation of the catalyser where prescribed can be done by qualified personnel of the AISIN Authorised Service Centre only.</b> Failure to observe this prescription could result in malfunction and/or damage to the unit.</li> </ul>

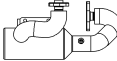
When installing the catalyser, always refer to the dedicated installation manual, which is included in the kit (part number AGBJ560F2 or AGBJ710F1 depending on models).

Each kit includes:

Parte		Aspetto
Catalyser	1	
Temperature sensor	1	
Gaskets for exhaust gas	2	
Mounting brackets	3	

- **Change supply gas type G20 – G31 and vice versa**

Change the outdoor unit PC board EEP dip switch setting, install the catalyser kit and the gas pressure external regulator. Refer to the dedicated sections of the present manual to change the gas type and install the regulator.

- **Change supply gas type G20 – G25 and vice versa or else G20 – G25.3 and vice versa**

In case of 16-20-25 HP, change the outdoor unit PC board EEP dip switch setting. Refer to the dedicated sections of the present manual to change the gas type.

In case of 30 HP, change the outdoor unit PC board EEP dip switch setting, install the catalyser kit and the gas pressure external regulator. Refer to the dedicated sections of the present manual to change the gas type and install the regulator.

- **Change supply gas type G25 – G31 and vice versa or else G25.3 – G31 and vice versa**

In case of 16-20-25 HP, change the outdoor unit PC board EEP dip switch setting, install the catalyser kit and the gas pressure external regulator. Refer to the dedicated sections of the present manual to change the gas type and install the regulator.

In case of 30 HP, change the outdoor unit PC board EEP dip switch setting. Refer to the dedicated sections of the present manual to change the gas type.

## 11-5. Making field settings with the remote controller







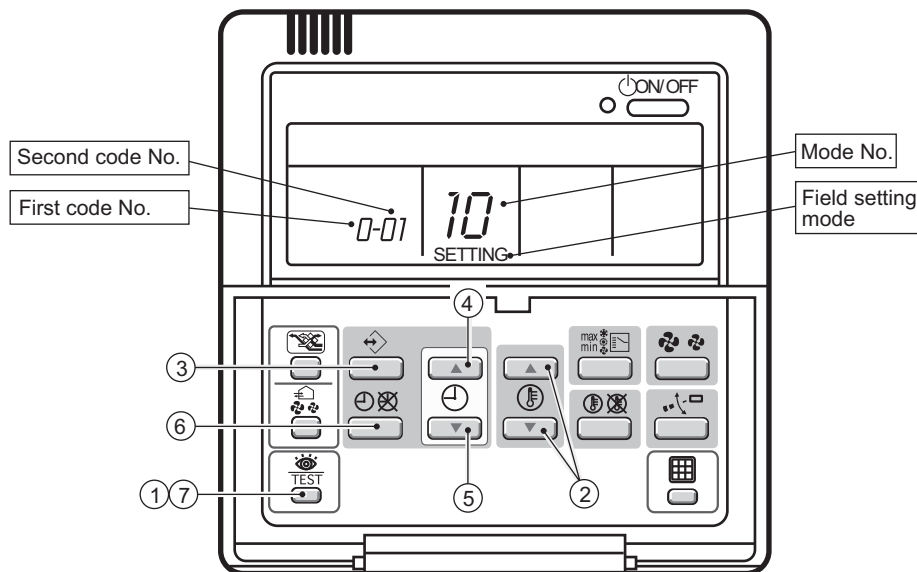

### ■ Master control setting

- What is master control?  
Only the master remote controller can select “cooling”, “heating”, and “dry”.
- How to make master control settings  
The remote controller on which you first press the “OPERATION CHANGE / MIN-MAX” button after installation of the indoor / outdoor unit is the master controller.
- How to change the master controller  
To change the master controller, refer to “SETTING THE MASTER REMOTE CONTROLLER” in the operation manual attached to the indoor unit.

### ■ Field settings



#### Setting procedure

- 1 In the normal mode, press the  button for 4 seconds or longer. The mode changes to the “field setting mode”.
- 2 Press the   buttons and select the “mode number” to set.
- 3 When configuring indoor units for group control (when selecting 20, 22, 23 and 25 mode numbers), press the  button and select the “indoor unit number” to set. (This step is not required at the time of group setting.)
- 4 Press the  (up) button to select the first code number.
- 5 Press the  (down) button to select the second code number.
- 6 To input current setting changes, press the  button once.
- 7 Press the  button for about 1 second. This returns the controller to the normal mode.

(Example) To set the interval for displaying the filter cleaning indicator to “Filter contamination-Heavy” when making group settings, select the mode number “10”, first code number “0” and second code number “02”.

## 11-6. List of settings and mode numbers

Mode No. *1	First code No.	Description of contents		Second code No. *2					
				01	02	03	04		
10(20)	0	Filter contamination - Heavy/ Light (Setting of filter sign display interval for cleaning) (Setting to reduce displaying period to half when filter contamination is heavy.)	Ultra-long-life type	Light	Approx. 10,000 H	Heavy	Approx. 5,000 H	-	-
			Long-life type		Approx. 2,500 H		Approx. 1,250 H		
			Standard type		Approx. 200 H		Approx. 100 H		
	1	Long-life filter type (Setting of filter sign display interval for cleaning) (Change setting when ultra-long filter is installed)	Standard (long-life filter)	Ultra-long life filter	-	Oil guard filter			
	2	Thermostat sensor in remote controller *3	Use both the unit sensor (or remote sensor if installed) AND the remote controller sensor. *5+6	Use unit sensor only (or remote sensor if installed). *5+6	Use remote controller sensor only. *5+6	-			
	3	Display of air filter cleaning sign (To be set when not setting filter cleaning sign)	Display	Not display	-	-			
	5	Information to be sent to I-manager, I-touch controller	Only unit sensor value (or remote sensor value if installed).	Sensor value as set by 10-2-0X or 10-6-0X.	-	-			
6	Thermostat sensor used for group control	Use unit sensor only (or remote sensor if installed). *6	Use both the unit sensor (or remote sensor if installed) AND the remote controller sensor. *4, 5, 6	-	-				
12(22)	0	Output signal X1-X2 of the optional adapter; KRP1B PCB unit	Indoor unit thermo-ON + compressor run	-	Operation	Malfunction			
	1	ON/OFF input from outside (T1/T2 input) (To be set when forced ON/OFF is to be operated from outside).	Forced OFF	ON/OFF operation	-	-			
	2	Thermostat differential changeover (To be set when using remote sensor)	1 °C	0.5 °C	-	-			
	3	Fan setting when thermostat OFF during heating operation (For capacity increase of air cleaning unit)	LL	Set speed	OFF*7	-			
	4	Differential automatic changeover	0 °C	1 °C	2 °C	3 °C*8			
	5	Automatic re-start after power failure (Return to the status before the blackout)	Disabled	Enabled	-	-			
13(23)	0	Setting for ceiling height (for AXAP model; setting for air flow rate) *9	Standard	High ceiling 1	High ceiling 2	-			
	1	Selection of air flow direction (To be set when installing a blocking pad kid)	4-way flow	3-way flow	2-way flow	-			
	3	Air flow direction selecting function (To be set when attaching decorative panel to air outlet)	Equipped	Not equipped	-	-			
	4	Air flow direction range setting	Upper	Normal	Lower	-			
	5	Setting of fan speed (Control with the air outlet at the time of phase control)	Standard	Option 1	Option 2	-			
15(25)	3	Drain pump operation with humidifying	Equipped	Not equipped	-	-			

Setting at indoor unit side

Mode No. *1	First code No.	Description of contents	Second code No. *2			
			01	02	03	04
1b	0	Permission level setting	Level 2	Level 3	–	–
	1	Away function	Not permitted	Permitted	–	–
	2	Thermostat sensor in remote controller (For limit operation and leave home function only)	Use	Not use	–	–

- \*1 All mode settings are made in the group mode. When making individual mode settings from indoor units, select the mode number in ( ) in the table.  
Note that individual mode settings can only be confirmed by selecting the number in ( ). In the group settings, even though all of the second code numbers are selectable, the display on the LCD remains in 01.
- \*2 The factory settings for the second number code depend on indoor unit type. For more details, refer to the installation and operation manual attached to each indoor unit.
- \*3 When the remote controller cannot be installed in a living space, thermostat sensor in the remote controller must be set to “Not use (10-2-02)”.
- \*4 If group control is selected and the remote controller sensor is used, then set 10-6-02 & 10-2-03.
- \*5 If settings 10-6-02+10-2-01 or 10-2-02 or 10-2-03 are set at the same time, then settings 10-2-01, 10-2-02 or 10-2-03 have priority.
- \*6 If settings 10-6-01+10-2-01 or 10-2-02 or 10-2-03 are set at the same time for group connection, 10-6-01 has priority and for individual connection, 10-2-01, 10-2-02 or 10-2-03 has priority.
- \*7 Use only in combination with optional remote sensor or when 10-2-03 is set.
- \*8 More settings are: Second code No.: 05 / 4°C, 06 / 5°C, 07 / 6°C, 08 / 7°C.
- \*9 Refer to the following table “Rough guide for setup for high ceiling installations” for more details.
- \* Do not make any settings not given in the table.
- \* The display is not shown if the indoor unit is not equipped with the function.
- \* When returning to the normal mode, “88” may be displayed in the LCD in order for the remote controller to initialize itself.
- \* Depending on the operation status, setting of fan speed may be different from actual fan speed.
- \* It is not possible to change field settings on the remote controller that is set to “sub”.

■ For the latest information of the high ceiling support setting or fan airflow setting, refer to the “Installation Manual” attached to the indoor unit.

## 12. Remote Control

### 12-1. Remote control using 2 remote controllers

#### ■ 1 indoor unit control with 2 remote controllers at 2 locations

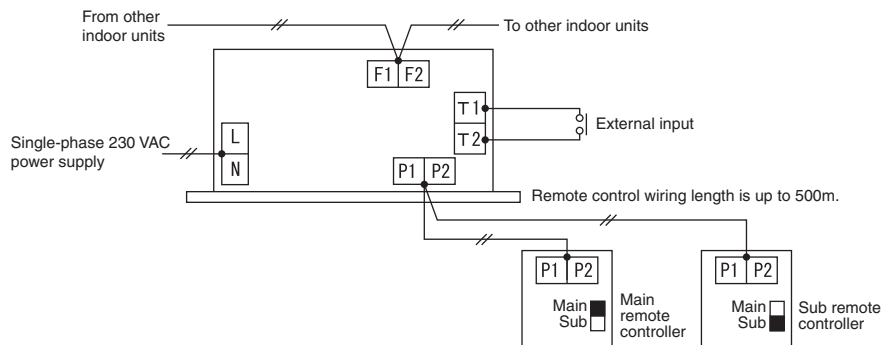

(Note) If main and sub remote controllers equipped with thermostat sensors are mounted in separate rooms, set the main remote controller thermostat to “Not use” when making field setting with the remote controller.

- A later command by either of the remote controllers can override a previous command by either to control the indoor unit operation.
- Only the thermostat in the main remote controller is recognized by the indoor unit when 2 remote controllers are installed.
- To set the remote controllers to main or sub, remove the front panels of the remote controllers and set the main/sub changeover switches on the PC boards to “Main” or “Sub”. Field settings made by remote controller can set only with the main remote controller.

### 12-2. Group control

#### ■ Simultaneous control of up to 16 units with 1 remote controller

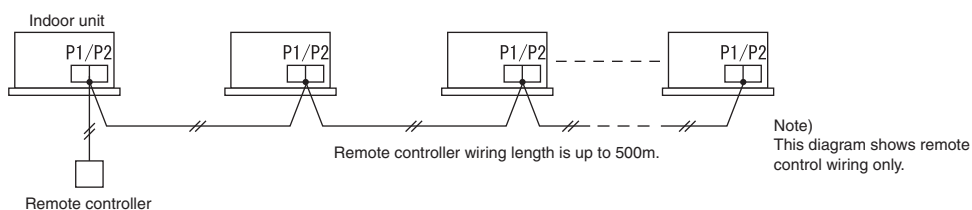

- Because the remote control wiring for group control has no polarity, P1 and P2 can be switched.
- All indoor units within the group have the same setting, and each indoor unit is controlled individually by its own built-in thermostat.
- At the time of group control, the remote controller thermostat is automatically set to “Not use”.
- Because the address is set automatically, it is not necessary to make group control address settings by remote controller.



## 13. Test Operation

### Caution



■ **Do not touch moving parts.**

You could be injured.

The fans or engine may automatically start running to protect the device or to maintain performance even if the GHP is stopped.

Be sure to turn OFF the power breaker when you need to touch the moving parts.

### 13-1. Before starting test operation

#### Important

- **Turn ON the main power supply and the electric leakage breaker inside the outdoor unit's control box at least 6 hours before the test operation to energize the crank case heater.**

1. Be sure to fully open the stop valves of the outdoor unit for both the liquid and vapor pipes, and attach the stopper ring to each of them.  
(Open the liquid stop valve first, and then open the vapor stop valve.)
2. Open the fuel gas valve.

### 13-2. Sequence of outdoor unit operation following power ON

When the power is first turned on, the system will first perform power master setting and address setting. (outdoor and indoor addresses.) Therefore, wait for up to 15 minutes until the unit starts operation.

Be sure to do the test operation after turning ON the power for the first time.

The following shows the procedure from turning ON the power to completion of the connection check.

#### Important reminder

- **After the system is ready for operation, ask the test operation service to perform test operation.**

## 1) Model information display

After turning ON the power, the model information is displayed for about 10 seconds (as shown below) and after that, proceed to “2) Connection check”.

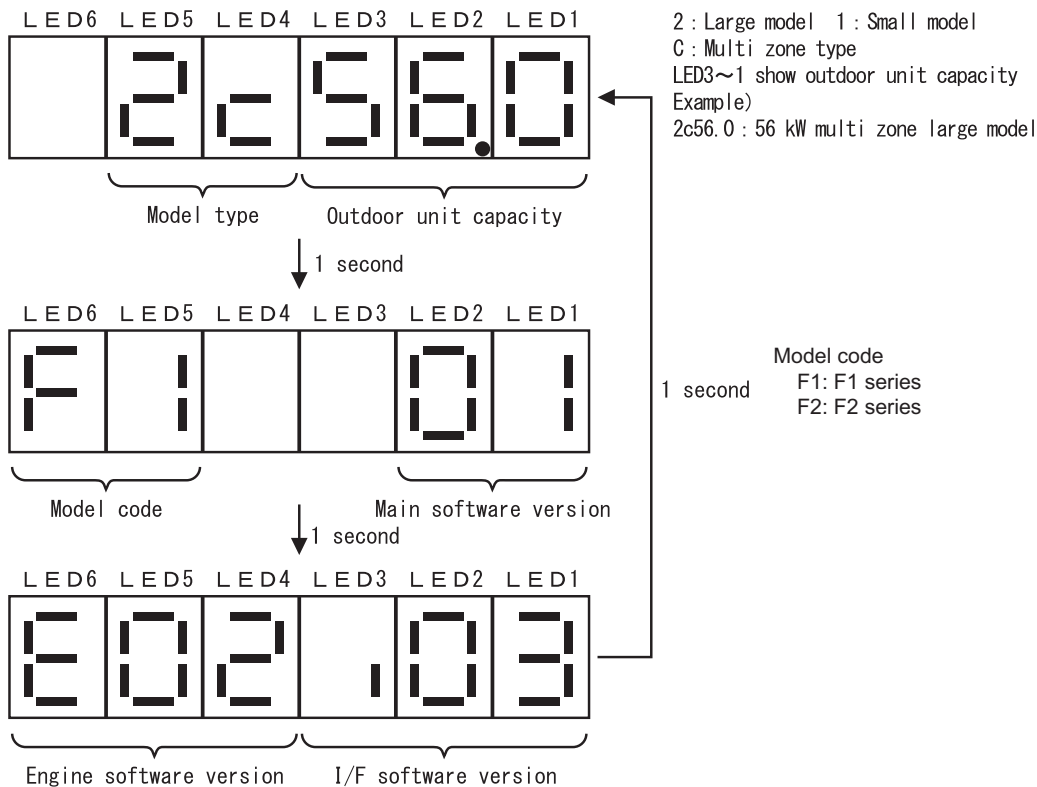

## 2) Connection check

This step checks indoor and outdoor unit connection condition. Display during the connection check is as follows:

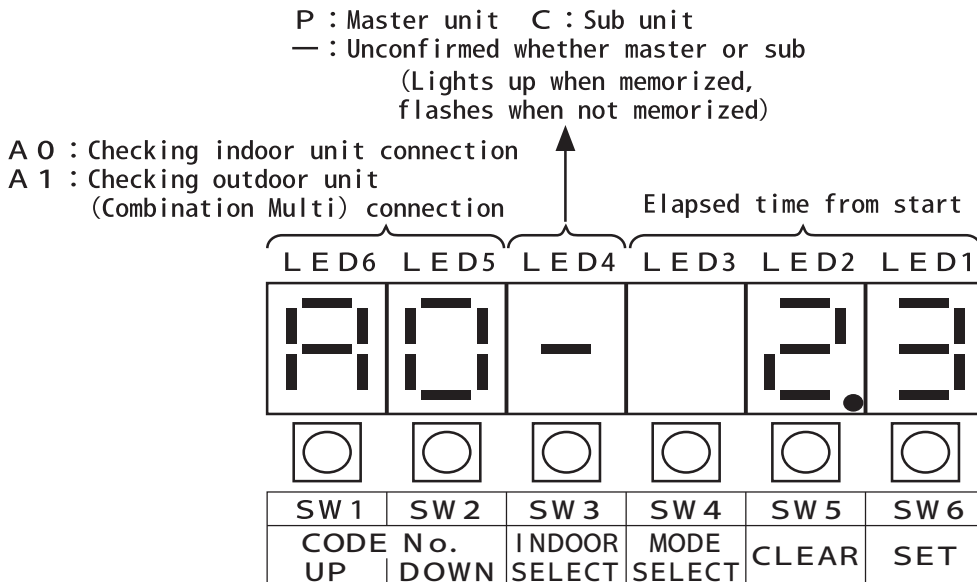

When the connection check is finished, operation automatically proceeds to the following step.

- If the connection condition is not recognized, operation proceeds to “3) Connection condition check”.
- If the connection condition is recognized, operation proceeds to “4) Connection condition display”.  
 (If re-wiring recognition is performed, the connection condition was not recognized.)

\* It takes about 6 to 15 minutes for connection check to finish.

### 3) Connection condition check

Check the master and sub outdoor unit displays to confirm that connections between outdoor and indoor units are correctly indicated.  
The display is as follows.

#### ■ With a Combination Multi master unit or single outdoor unit

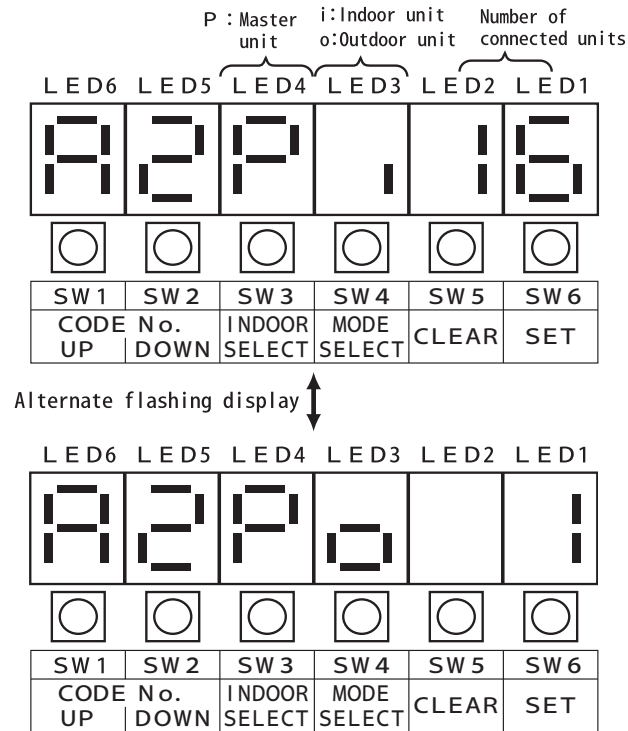

#### ■ With a Combination Multi sub unit

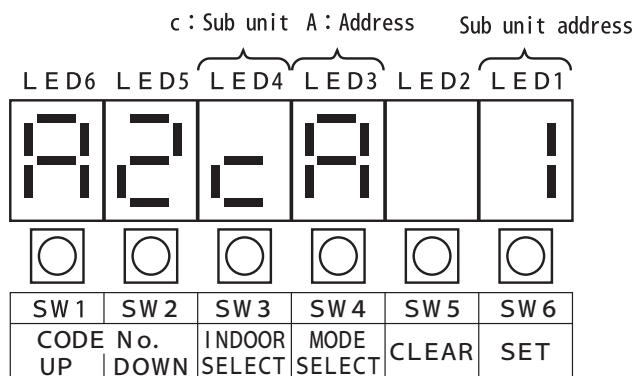

Check both the master and the sub unit displays, and make sure that the number of connected indoor and outdoor units and the sub unit addresses are properly displayed.

If the connection condition display agrees with the actual condition, press the SET switch on the master unit for 2 seconds or longer to confirm the connection condition. (The current connection condition is memorized.)

After confirming the connection status, the display automatically proceeds to “4) Connection condition display”.

If the connection condition is not correct, turn OFF the power supply and check the wiring, and then turn the power supply ON again.

The sub unit proceeds automatically to “4) Connection condition display” after the master unit memorizes the connection condition information.

#### 4) Connection condition display

The connection condition is displayed (see illustration below) for about 10 seconds. After that, the display automatically changes to normal operation mode (running hour display).

##### ■ With a Combination Multi master unit or single outdoor unit

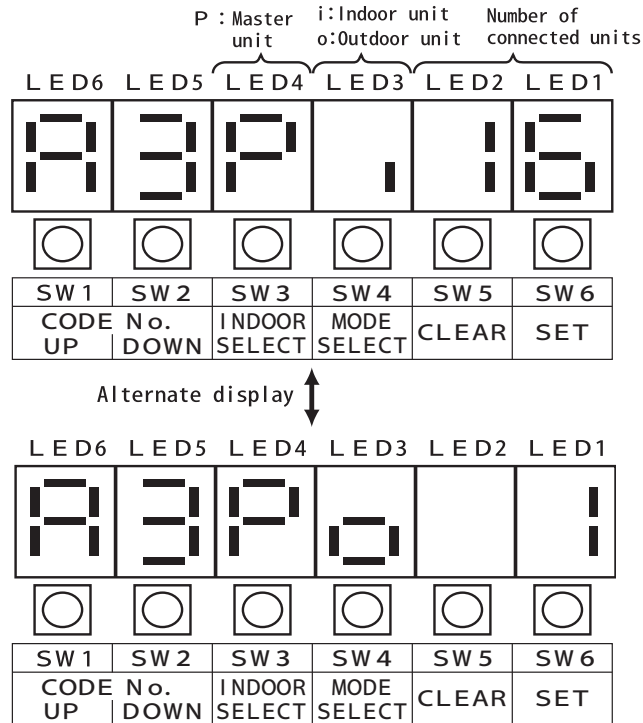

##### ■ With a Combination Multi sub unit

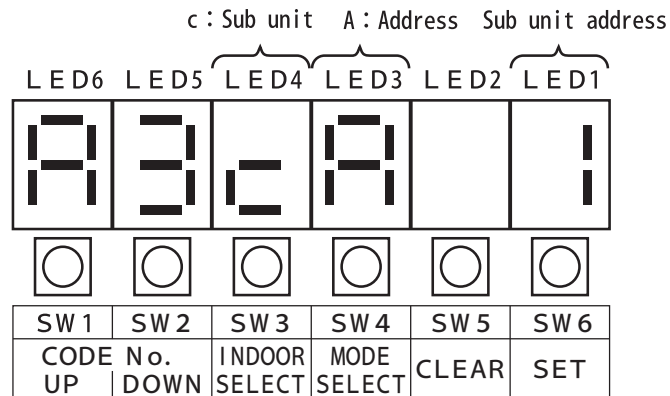

## 5) Error display during automatic address

- If an error is detected, the error code is displayed as shown below.

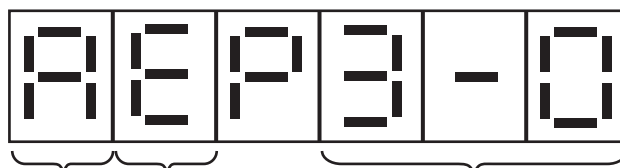

A: Normal mode    Error    Error code

Error code	Description
3-0	Unconnected indoor unit, Inconsistent indoor unit count
4-1	Communication failure between outdoor units 2 (Automatic address error in combined installation)
4-2	Communication failure between outdoor units 3 (Master-sub model inconsistency in combined installation)
4-3	Communication failure between outdoor units 4 (Storage data error in combined installation)
4-4	Communication failure between outdoor units 5 (The number of connected sub units is insufficient in combined installation.)
4-5	Communication failure between outdoor units 6 (Automatic address time over in combined installation)

## 13-3. When installing additional indoor / outdoor units or replacing the indoor / outdoor unit PCBs

### ■ When changing the number of indoor units or replacing indoor unit PCBs

Perform re-wiring recognition of the indoor units.

### ■ When changing the number of outdoor units or replacing outdoor unit PCBs

Perform re-wiring recognition of the outdoor units.



## ■ Indoor / outdoor unit re-wiring recognition process

Indoor / outdoor unit re-wiring recognition is performed in the “check mode”. Disconnect the personal computer, and select the check mode.

To select the check mode, refer to the “11-2. 1) How to change the monitor mode to the check mode” on page 65.

- 1 Press the CODE No. UP or CODE No. DOWN switch and select the check code No. 01 as indicated in the following figure.

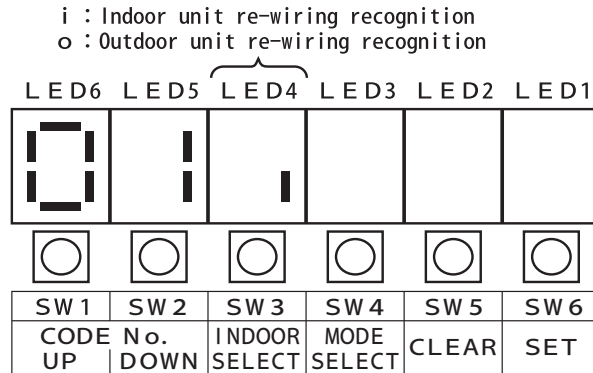

- 2 Press the INDOOR SELECT switch and select “Indoor unit re-wiring recognition” (indicated with i) and “Outdoor unit re-wiring recognition” (indicated with o).
- 3 Hold down the SET switch for 2 seconds or more. The display is shown as follows.

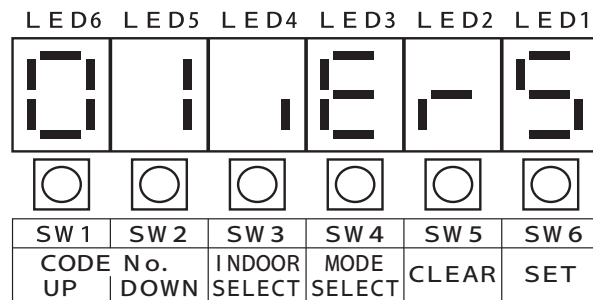

- 4 Press the SET switch again for 2 seconds or longer while the above-mentioned display (step 3) is shown.  
Selected re-wiring is recognized and the display is as follows:

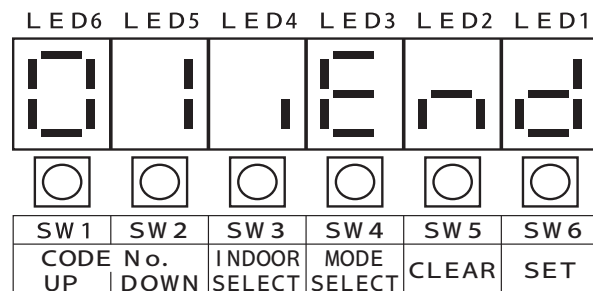

After completing re-wiring recognition, return to “13-2. 2) Connection check” and check the connection condition again.

## 14. Troubleshooting

Perform inspection in accordance with the error displays on the remote controller and the outdoor unit circuit board.

### 1) Error code display

Remote controller error code	Outdoor unit error code	Description of breakdown
A0	63-n	Indoor unit: External protective device activation
A1	20-n	Indoor unit: Circuit board Assy, EEPROM setting error
A3	95-n	Indoor unit: Drain water level system malfunction
A6	15-n	Indoor unit: Locked fan
A7	35-n	Indoor unit: Swing flap motor failure
A8	25-n	Indoor unit: Abnormal power supply voltage
A9	21-n	Indoor unit: Electronic expansion valve drive unit failure
AF	30-n	Indoor unit: Drainage failure
AH	31-n	Indoor unit: Dust collector failure Indoor unit: Up-down unit error
AJ	22-n	Indoor unit: Capacity setting error
C1	27-n	Indoor unit: Transmission failure (indoor circuit board - fan circuit board) Indoor unit: Transmission failure between up-down grills
C4	18-n	Indoor unit: Liquid pipe thermistor error
C5	19-n	Indoor unit: Vapor pipe thermistor error
C6	28-n	Indoor unit: Combination failure (indoor circuit board - fan circuit board)
C9	97-n	Indoor unit: Intake air thermistor failure
CA	98-n	Indoor unit: Discharge air thermistor failure
CE	99-n	Indoor unit: Human detection / floor temperature detection sensor failure
CJ	17-n	Indoor unit: Remote controller sensor failure
U0	88-5	Outdoor unit: Refrigerant empty
U4	-	Indoor unit detection Transmission failure between indoor unit and outdoor/BS unit Transmission failure between outdoor unit and BS unit
-	3-0	Outdoor unit detection Transmission failure between outdoor unit and indoor unit Transmission failure between outdoor unit and BS unit
U5	1-n	Transmission failure between remote controller and indoor unit
	-	Remote control board failure or remote control setting failure
U7	4-0	Communication failure between outdoor units 1
	4-1	Communication failure between outdoor units 2
	4-2	Communication failure between outdoor units 3
	4-3	Communication failure between outdoor units 4
	4-4	Communication failure between outdoor units 5
	4-5	Communication failure between outdoor units 6
U8	-	Communication failure between outdoor units 7
U9	5-n	Outdoor unit detection Transmission failure between outdoor unit and indoor unit Transmission failure between outdoor unit and BS unit
	-	Transmission failure between other indoor unit and outdoor unit in the same system Transmission failure between other BS units and indoor/outdoor units in the same system

\* "n" of outdoor unit error code ??-n indicates the indoor unit address.

\* RC error codes A7, AF, AH, CJ and UC indicate minor errors that do not stop operation (alerts or warnings).

\* The outdoor unit error codes are displayed only when a system error has occurred and only while the CODE No. UP switch is pressed on the maintenance board.

Remote controller error code	Outdoor unit error code	Description of breakdown
UA	43-1	Indoor unit connection capacity over
	44-n	Indoor unit - BS unit - outdoor unit combination failure (model, number of units, etc.) Indoor unit - remote controller combination failure (target remote controller) BS unit connection position failure or incorrect wiring Circuit board type setting failure
UC	36-n	Centralized control address duplication
UE	23-n	Transmission failure between indoor unit and centralized remote controller
UF	24-n	No system setting or incorrect wiring
UH	-	System failure
AA	-	Outdoor unit: Self-air-conditioning operation standby (thermo OFF)
AC	-	Outdoor unit: Self-air-conditioning operation standby (remote controller OFF)
E1	40-0	Outdoor unit: EEPROM failure
	40-1	Outdoor unit: EEPROM model code failure
	40-2	Outdoor unit: Inconsistency between main microcomputer and engine microcomputer
	84-3	Outdoor unit: Communication failure between main microcomputer and engine microcomputer
	84-4	Outdoor unit: Communication failure between interface and main microcomputer
	84-5	Outdoor unit: Communication failure between main microcomputer and inverter
E3	86-0	Outdoor unit: System high pressure failure Outdoor unit: Refrigerant high pressure failure 1
	86-1	Outdoor unit: Refrigerant high pressure failure 2
E4	88-0	Outdoor unit: System low pressure failure Outdoor unit: Refrigerant low pressure failure
E7	86-10	Outdoor unit: Failure in all heat exchanger fan motor systems
E7	86-11	Outdoor unit: Heat exchanger fan 1 starting failure
	86-12	Outdoor unit: Heat exchanger fan 2 starting failure
	86-21	Outdoor unit: Heat exchanger fan 1 revolution failure
	86-22	Outdoor unit: Heat exchanger fan 2 revolution failure
EA	57-0	Outdoor unit: 4-way changeover valve switching failure (Detected only in the equipment compatible with the Combination Multi specifications.)
EC	80-0	Outdoor unit: Engine cooling water over-temperature
	80-3	Outdoor unit: Engine cooling water temperature does not rise.
EH	80-10	Outdoor unit: Engine coolant pump starting failure
	80-30	Outdoor unit: IPM failure
F3	91-0	Outdoor unit: Excessive compressor discharge pipe temperature
F4	87-0	Outdoor unit: Excessive compressor intake temperature
	87-2	Outdoor unit: Compressor intake superheat temperature does not rise.
FE	81-0	Outdoor unit: Engine oil pressure reduction failure
FF	58-0	Outdoor unit: Inadequate refrigerant oil
FJ	47-0	Outdoor unit: Exhaust air over-temperature
H3	76-0	Outdoor unit: Disconnected refrigerant high pressure switch 1
	76-10	Outdoor unit: Disconnected refrigerant high pressure switch 2
H9	61-0	Outdoor unit: Disconnected outside air temperature thermistor
	61-1	Outdoor unit: Short-circuited outside air temperature thermistor
HC	70-0	Outdoor unit: Disconnected engine cooling water thermistor
	80-1	Outdoor unit: Short-circuited engine cooling water thermistor

\* "n" of outdoor unit error code ??-n indicates the indoor unit address.

\* RC error codes A7, AF, AH, CJ and UC indicate minor errors that do not stop operation (alerts or warnings).

\* The outdoor unit error codes are displayed only when a system error has occurred and only while the CODE No. UP switch is pressed on the maintenance board.



Remote controller error code	Outdoor unit error code	Description of breakdown
HJ	80-2	Outdoor unit: Engine cooling water empty
PA	FE-8	Outdoor unit: Battery replacement sign
PH	FE-0	Outdoor unit: Battery replacement
U2	FE-1	Outdoor unit: Battery over-temperature
	FE-2	Outdoor unit: Battery charge voltage error
	FE-3	Outdoor unit: Battery undervoltage
	FE-4	Outdoor unit: Disconnected battery temperature thermistor
	FE-5	Outdoor unit: Short-circuited battery temperature thermistor
	FE-6	Outdoor unit: Battery voltage detection error
	FE-7	Outdoor unit: Status thyristor failure
L0	FF-0	Outdoor unit: Inverter DC intermediate overvoltage
	FF-1	Outdoor unit: Inverter DC intermediate undervoltage
	FF-2	Outdoor unit: Inverter IPM error (overheat)
	FF-3	Outdoor unit: Inverter IPM error (overcurrent)
	FF-4	Outdoor unit: Inverter IPM error (voltage shortage)
	FF-5	Outdoor unit: Inverter overcurrent
	FF-6	Outdoor unit: Inverter overload
	FF-7	Outdoor unit: Inverter output overvoltage
	FF-8	Outdoor unit: Self-generating output voltage shortage
	FF-9	Outdoor unit: Inverter output voltage sensor error
	FF-10	Outdoor unit: Inverter output current sensor error
	FF-11	Outdoor unit: Inverter DC intermediate voltage sensor error
	FF-12	Outdoor unit: Self-generating output overvoltage prevention circuit variation overload detection
	FF-13	Outdoor unit: Inverter 12 V voltage error
	FF-14	Outdoor unit: Inverter output frequency error
FF-15	Outdoor unit: Frequency measurement system error	
HF	EE-0	Outdoor unit: Periodic inspection
J3	78-0	Outdoor unit: Disconnected compressor discharge pipe temperature thermistor 1
	78-1	Outdoor unit: Disconnected compressor discharge pipe temperature thermistor 2
	78-2	Outdoor unit: Disconnected compressor discharge pipe temperature thermistor 3
	91-2	Outdoor unit: Short-circuited compressor discharge pipe temperature thermistor 1
	91-3	Outdoor unit: Short-circuited compressor discharge pipe temperature thermistor 2
J4	55-0	Outdoor unit: Disconnected accumulator outlet temperature thermistor
	55-2	Outdoor unit: Short-circuited accumulator outlet temperature thermistor
J5	53-0	Outdoor unit: Disconnected compressor intake temperature thermistor
	53-2	Outdoor unit: Short-circuited compressor intake temperature thermistor
J6	65-0	Outdoor unit: Disconnected outdoor heat exchanger liquid temperature thermistor
	65-2	Outdoor unit: Short-circuited outdoor heat exchanger liquid temperature thermistor
	85-0	Outdoor unit: Disconnected outdoor heat exchanger vapor temperature thermistor
	85-2	Outdoor unit: Short-circuited outdoor heat exchanger vapor temperature thermistor
J7	66-0	Outdoor unit: Disconnected sub heat exchanger liquid temperature thermistor
	66-1	Outdoor unit: Short-circuited sub heat exchanger liquid temperature thermistor

\* “n” of outdoor unit error code ??-n indicates the indoor unit address.

\* RC error codes A7, AF, AH, CJ and UC indicate minor errors that do not stop operation (alerts or warnings).

\* The outdoor unit error codes are displayed only when a system error has occurred and only while the CODE No. UP switch is pressed on the maintenance board.



Remote controller error code	Outdoor unit error code	Description of breakdown
JA	73-0	Outdoor unit: Refrigerant high pressure sensor 1 failure 1
	73-1	Outdoor unit: Refrigerant high pressure sensor 1 failure 2
	73-2	Outdoor unit: Refrigerant high pressure sensor 2 failure 1
	73-3	Outdoor unit: Refrigerant high pressure sensor 2 failure 2
JC	88-4	Outdoor unit: Refrigerant low pressure sensor failure
JE	71-0	Outdoor unit: Disconnected engine oil pressure switch
JJ	72-0	Outdoor unit: Disconnected engine compartment temperature thermistor
	72-1	Outdoor unit: Short-circuited engine compartment temperature thermistor
	72-6	Outdoor unit: Exhaust air temperature rising failure
LE	75-1	Outdoor unit: Igniter undervoltage
	75-2	Outdoor unit: Igniter disconnection
	75-3	Outdoor unit: Igniter overvoltage
	75-10	Outdoor unit: Starter transformer voltage cut off
LF	84-0	Outdoor unit: Engine starting failure
LH	68-10	Outdoor unit: Generating converter minor malfunction
	68-20	Outdoor unit: Generating converter major malfunction
-	68-30	Outdoor unit: No generator output
LJ	75-0	Outdoor unit: Engine stop
	75-4	Outdoor unit: Engine accident fire (cylinder 1)
	75-5	Outdoor unit: Engine accident fire (cylinder 2)
	75-6	Outdoor unit: Engine accident fire (cylinder 3)
	75-7	Outdoor unit: Engine accident fire (cylinder 4)
P8	74-1	Outdoor unit: Insufficient engine starting speed
	74-4	Outdoor unit: Engine speed control failure
	82-0	Outdoor unit: Engine overspeed failure 1
	82-1	Outdoor unit: Engine overspeed failure 2
PE	74-7	Outdoor unit: Output failure of electromagnetic gas valve
	74-8	Outdoor unit: Gas type setting change forgetting error
PF	60-0	Outdoor unit: Unintended starter operation
U7	3-96	External control adapter reception error
-	3-97	Auto address re-execution (interface microcomputer instantaneous power interruption)
	3-98	Power-on signal reception from indoor unit
	3-99	Failure of normal-transmission reception from interface communication module

\* "n" of outdoor unit error code ??-n indicates the indoor unit address.

\* RC error codes A7, AF, AH, CJ and UC indicate minor errors that do not stop operation (alerts or warnings).

\* The outdoor unit error codes are displayed only when a system error has occurred and only while the CODE No. UP switch is pressed on the maintenance board.

## 2) Cancelling the error codes

- After repairing the failed part, press the ON/OFF button on the remote controller. The error code display disappears and operation status changes to "STOP".
- Operation restarts by pressing the ON/OFF button of the remote controller again.

# 15. Installation Check List

Installation	Outdoor unit	<input type="checkbox"/> Are there any problems with the exterior and interior of the outdoor unit? <input type="checkbox"/> Is there any possibility that a short circuit operation could occur due to outdoor unit exhaust heat? <input type="checkbox"/> Is there specified space for air flow and servicing? <input type="checkbox"/> Is there any possibility that discharged air from the outdoor unit or engine exhaust gas accumulates inside the room or flows into the room? <input type="checkbox"/> Is there proper drainage from the outdoor unit? <input type="checkbox"/> Is there any possibility that the exhaust gas from the outdoor unit blows directly toward the plants or animals?
	Indoor unit	<input type="checkbox"/> Are there any problems with the exterior and interior of the indoor unit? <input type="checkbox"/> Is the downward gradient for drain pipe 1/100 or more? <input type="checkbox"/> Is there specified space for air flow and servicing? <input type="checkbox"/> Is centering of the pulley or belt tension of the indoor unit appropriate? (If the indoor unit uses fan belts.)
Refrigerant piping installation		<input type="checkbox"/> Is the number of connected indoor units within the limit? <input type="checkbox"/> Is the total capacity for the connected indoor units within the limit? <input type="checkbox"/> Are the lengths and differences in height of the refrigerant piping within the permissible ranges? <input type="checkbox"/> Are the branch pipes properly installed? <input type="checkbox"/> Is the piping properly insulated? <input type="checkbox"/> Has the proper amount of additional refrigerant been added? <input type="checkbox"/> Have you written down the installation record and refrigerant amount on the "POINTS FOR INSTALLATION" plate with an oil-based marker? <input type="checkbox"/> Did you attach the stopper ring after fully opening each stop valve?
Drain piping installation		<input type="checkbox"/> Have you installed the exhaust drain piping in accordance with the specifications? <input type="checkbox"/> Do the outdoor unit exhaust drain and indoor unit drain flow into the separate receptacles? <input type="checkbox"/> Have you checked that the drain water drains properly through the drain piping? <input type="checkbox"/> Is the drain piping properly insulated?
Gas piping		<input type="checkbox"/> Are there any fuel gas leaks? <input type="checkbox"/> Does the type of gas supplied match the type indicated on the name plate?
Electric wiring installation		<input type="checkbox"/> Are the power supply wire and signal wires connected properly? <input type="checkbox"/> Is the outdoor unit properly grounded? <input type="checkbox"/> Are 2-core cables used for the signal wire instead of multi-core cables? <input type="checkbox"/> Is the wiring length within the permissible range? Is the wire thickness proper? (After power-on)
Options		<p><b>[Check the following items additionally if the outdoor unit is installed in a cold district or a heavy snowfall area.]</b></p> <input type="checkbox"/> Is the snowproof hood installed? When the snowproof hood is installed, is the exhaust pipe extended? <input type="checkbox"/> Is the heater kit installed for cold regions? <input type="checkbox"/> Is the drain hose with heater inserted into the back? <input type="checkbox"/> Is the hose clip of the drain hose with heater attached? <p><b>[Check the following item as well if the vibration of the outdoor unit can cause problems]</b></p> <input type="checkbox"/> Has the antivibration mount been installed?



# Technical specifications – DX systems

Outdoor unit			AWGP450F1-(F)X	AWGP560F1-(F)X	AWGP710F1-(F)X	AWGP850F1-(F)X	
Rated output			16 HP	20 HP	25 HP	30 HP	
Rated cooling capacity *	kW		45,0	56,0	71,0	85,0	
Rated heating capacity **	kW		50,0	63,0	80,0	95,0	
Maximum heating capacity	kW		53,0	67,0	84,0	95,0	
Maximum engine heat recovery	kW		15,7	19,5	27,2	35,6	
Energy efficiency	GUE cooling	-	1,43	1,44	1,31	1,19	
	GUE heating	-	1,68	1,65	1,48	1,40	
	SPER cooling	-	2,39	2,44	2,42	2,17	
	SPER heating	-	1,48	1,55	1,54	1,52	
Electrical features	Power supply	V	AC 230 single phase				
	Starting current	A	18 A				
	External safety breaker	type	C 20 / 0,3 A (cl. AC) stand-alone installation – C32 / 0,3 A (cl. AC) combined installation				
	Power consumption	Cooling	kW	0,645	0,914	1,19	1,74
		Heating	kW	0,505	0,628	0,744	1,68
	Running current	Cooling	A	2,8	4,0	5,2	7,5
Heating		A	2,2	2,7	3,2	7,3	
Fuel gas	Consumption	Cooling	kW	31,4	38,9	54,4	71,2
		Heating	kW	29,8	38,1	53,9	68,0
		Maximum	kW	40,1	56,9	79,6	86,8
	Supply pressure	<b>Category</b>		<b>Country</b>		<b>Test pressure</b>	
I12H3+		IT – GB – IE – ES – GR - PT		G20-20 mbar G30/G31-30/37 mbar			
I12H3B/P		DK – FI – SE – NO – SI – SK CZ – EE – LV – LT – LU		G20-20 mbar G30/G31-30 mbar			
I12H3B/P		HU		G20-25 mbar G30/G31-30 mbar			
I12ER3+		FR		G20/G25-20/25 mbar G30/G31-28/30 mbar			
I12L3B/P		NL		G25-25 mbar G30/G31-30 mbar			
I2E		DE		G20-20 mbar			
I2H		AT		G20-20 mbar			
I2H		CH		G20-20 mbar			
I2ER(B)		BE		G20/G25-20/25 mbar			
I3+		BE		G30/G31-28/30 mbar			
I3B/P		CY		G30/G31-30 mbar			
I3B/P		MT		G31-30mbar			
Engine	Type	Water cooled, vertical type, 4 cycle, 4 cylinder					
	Displacement	cm <sup>3</sup>	1.998				
	Rated output	kW	10,0	12,4	15,7	2.237	
	Revolution range	Cooling	rpm	500~1.455	500~1.780	500~2.300	500~2.525
		Heating	rpm	500~2.330	500~2.795	500~2.795	500~3.000
	Lubricant	Type	AISIN GHP OIL FL10.000 - G (refill every 10.000 ore, replacement every 30.000 ore)				
		Quantity	lt.	30	32	37	37
Coolant	Type	AISIN Coolant S					
	Quantity	lt.	23		26		
	Concentration	%	50 (for outdoor temperatures up to -20°C)				
Compressor	Type x number of units	Scroll X 2				Scroll X 3	
	Specified refrigeration oil	NL 10					
	Quantity	lt.	4				
	Transmission	Poli V belt					
Refrigerant	Type	R410A					
	Factory charge	kg	11,5				
Fan (2 x propeller fan)	Total flow rate	m <sup>3</sup> / min	291	319	370	420	
Noise level	Sound pressure	dB(A)	58	59	62	65	
	Sound power	dB	75	76	82	86	
Piping	Refrigerant	Gas	Ø 28,6		Ø 31,8		
		Liquid	Ø 15,9		Ø 19,1		
	Fuel gas	R 3 / 4"					
	Exhaust drain	Ø 15 (Ø 30 cold district spec) outer diameter					
Exhaust gas	Ø 100						
Piping permissible length (actual / equivalent)		165 / 190					
Permissible height difference between indoor units		15					
Permissible height difference between outdoor unit and indoor units		+ 50 / - 40					
External dimension	Height	2.245					
	Width	1.660					
	Depth	880					
Weight	kg	765		795		870	
Connectable indoor units	Number (standard / cold district)	32 / 26		40 / 33		52 / 41	63 / 50
	Capacity	50 – 160 standard / 50 – 130 cold district					

\* Outdoor temperature 35°C DB – indoor temperature 27°C DB

\*\* Outdoor temperature 7°C DB – indoor temperature 20°C DB

# Technical specifications – AWS standard systems

Outdoor unit			AWGP450F1-(F)A	AWGP560F1-(F)A	AWGP710F1-(F)A	AWGP850F1-(F)A	
<b>Rated output</b>			<b>16 HP</b>	<b>20 HP</b>	<b>25 HP</b>	<b>30 HP</b>	
Rated cooling capacity *	kW		42,5	53,0	63,5	74,5	
Rated heating capacity **	kW		50,0	62,5	77,0	87,5	
Maximum heating capacity	kW		53,5	68,0	77,0	91,0	
Maximum engine heat recovery	kW		19,5	23,5	30,5	44,5	
Energy efficiency	GUE cooling	-	1,42	1,23	1,13	1,05	
	GUE heating	-	1,47		1,42		
	SPER cooling	-	1,89		1,87	1,91	
	SPER heating	-	1,57	1,55	1,54	1,51	
Electrical features	Power supply	V	AC 230 single phase				
	Starting current	A	18 A				
	External safety breaker	type	C 20 / 0,3 A (cl. AC) stand-alone installation				
	Power consumption	Cooling	kW	0,645	0,914	1,19	1,74
		Heating	kW	0,505	0,628	0,744	1,68
	Running current	Cooling	A	2,8	4,0	5,2	7,5
Heating		A	2,2	2,7	3,2	7,3	
Fuel gas	Consumption	Cooling	kW	30,0	43,0	56,0	70,7
		Heating	kW	34,0	42,5	54,2	61,5
		Maximum	kW	37,3	53,2	58,5	75,7
	Supply pressure	<b>Category</b>		<b>Country</b>		<b>Test pressure</b>	
I12H3+		IT – GB – IE – ES – GR - PT		G20-20 mbar G30/G31-30/37 mbar			
I12H3B/P		DK – FI – SE – NO – SI – SK CZ – EE – LV – LT – LU		G20-20 mbar G30/G31-30 mbar			
I12H3B/P		HU		G20-25 mbar G30/G31-30 mbar			
I12ER3+		FR		G20/G25-20/25 mbar G30/G31-28/30 mbar			
I12L3B/P		NL		G25-25 mbar G30/G31-30 mbar			
I2E		DE		G20-20 mbar			
I2H		AT		G20-20 mbar			
I2H		CH		G20-20 mbar			
I2ER(B)		BE		G20/G25-20/25 mbar			
I3+		BE		G30/G31-28/30 mbar			
I3B/P		CY		G30/G31-30 mbar			
I3B/P		MT		G31-30mbar			
Engine	Type	Water cooled, vertical type, 4 cycle, 4 cylinder					
	Displacement	cm <sup>3</sup>	1.998				
	Rated output	kW	10,0	12,4	15,7	2.237	
	Revolution range	Cooling	rpm	600~1.400	600~1.800	600~2.300	500~2.400
		Heating	rpm	500~2.400	500~2.600	500~2.795	500~3.000
	Lubricant	Type	AISIN GHP OIL FL10.000 - G (refill every 10.000 ore, replacement every 30.000 ore)				
		Quantity	lt.	30	32	37	37
Coolant	Type	AISIN Coolant S					
	Quantity	lt.	23		26		
	Concentration	%	50 (for outdoor temperatures up to -20°C)				
Compressor	Type x number of units	Scroll X 2				Scroll X 3	
	Specified refrigeration oil	NL 10					
	Quantity	lt.	4				
	Transmission	Poli V belt					
Refrigerant	Type	R410A					
	Factory charge	kg	11,5				
Fan (2 x propeller fan)	Total flow rate	m <sup>3</sup> / min	291	319	370	420	
Noise level	Sound pressure	dB(A)	58	59	62	65	
	Sound power	dB	75	76	82	86	
Piping	Refrigerant	Gas	Ø 28,6		Ø 35,0		
		Liquid	Ø 15,9		Ø 19,1		
	Fuel gas	R 3 / 4"					
	Exhaust drain	Ø 15 (Ø 30 cold district spec) outer diameter					
Exhaust gas	Ø 100						
Piping permissible length (actual / equivalent)		165 / 190					
Permissible height difference between indoor units		15					
Permissible height difference between outdoor unit and indoor units		+ 50 / - 40					
External dimension	Height	2.245					
	Width	1.660					
	Depth	880					
Weight	kg	765		795		870	
Connectable indoor units	Number (standard / cold district)	1					
	Capacity	100					

\* Outdoor temperature 35°C DB – indoor temperature 27°C DB

\*\* Outdoor temperature 7°C DB – indoor temperature 20°C DB

## Technical specifications – AWS ECO systems

Outdoor unit		AWGP450F1-(F)E	AWGP560F1-(F)E	AWGP710F1-(F)E	AWGP850F1-(F)E	
Rated output		16 HP	20 HP	25 HP	30 HP	
Rated cooling capacity *	kW	42,5	53,0	63,5	74,5	
Rated heating capacity **	kW	41,0	53,5	62,5	75,0	
Maximum engine heat recovery	kW	19,5	23,5	30,5	44,5	
Energy efficiency	GUE cooling	-	1,42	1,23	1,13	1,05
	GUE heating	-	1,59	1,60	1,47	1,49
	SPER cooling	-	1,89		1,87	1,91
	SPER heating	-	1,57	1,55	1,54	1,51

\* Outdoor temperature 35°C DB – indoor temperature 27°C DB

\*\* Outdoor temperature 7°C DB – indoor temperature 20°C DB

## Technical specifications – AWS Low Temp systems

Outdoor unit		AWGP710F1-(F)L	AWGP850F1-(F)L	
Rated output		25 HP	30 HP	
Rated cooling capacity *	kW	65,5	74,5	
Rated heating capacity **	kW	75,0	87,5	
Maximum engine heat recovery	kW	36,5	44,5	
Energy efficiency	GUE cooling	-	1,13	1,05
	GUE heating	-	1,49	1,42
	SPER cooling	-	1,93	1,91
	SPER heating	-	1,54	1,51

\* Outdoor temperature 35°C DB – indoor temperature 27°C DB

\*\* Outdoor temperature 7°C DB – indoor temperature 20°C DB

Refer to the specification table of AWS standard for all other specifications.

NOTE:

# **AI SIN**

member of **TOYOTA** group

**TECNO CASA**  
CLIMATIZZAZIONE

Sole European Distributor **AI SIN**  
Gas Heat Pump (GHP) / Microgenerator (MCHP)

**Tecnocasa S.r.l.**

via Manzoni, 17 - 60025 Loreto (AN) Italy  
tel. +39 071 977805 fax +39 071 976481  
info@tecno-casa.com

[www.tecno-casa.com](http://www.tecno-casa.com)